

Canon EF LENS

EF100mm f/2.8L MACRO IS USM



ENG

Instruction

IMAGE STABILIZER
ULTRASONIC

Thank you for purchasing a Canon product.

The Canon EF100mm f/2.8L MACRO IS USM lens is a macro lens dedicated to Canon EOS cameras. It is equipped with an Image Stabilizer and can shoot close-ups up to 1:1 as well as normal shots.

- "IS" stands for Image Stabilizer.
- "USM" stands for Ultrasonic Motor.

Features

1. The Image Stabilizer provides the effect of having a shutter speed about four stops faster during normal shooting.*
This function provides optimal image stabilization depending on shooting conditions (such as shooting still subjects and following shots).
2. And with the vibration gyro and acceleration sensor, the image stabilization is highly effective even for close-up shots.
3. UD lens elements for excellent imaging performance.

4. Ultrasonic motor (USM) for quick and quiet autofocus.
5. Manual focusing is available after the subject comes into focus in autofocus mode (ONE SHOT AF).
6. A truly round aperture hole results in a nicer background blur.
7. A Canon macro flash makes it easy to take close-up pictures with a flash. The inner focusing mechanism enables AF photography while the macro flash is attached.
8. Tight seal structure ensures excellent dust-proof and drip-proof performance.

* Based on [1/focal length] second.
To prevent blur caused by camera shake during normal shooting, the shutter speed should be the reciprocal of the current focal length (1/focal length) or faster.

Conventions used in this instruction



Warning to prevent lens or camera malfunction or damage.



Supplementary notes on using the lens and taking pictures.

Safety Precautions

Safety Precautions

- **Do not look at the sun or a bright light source through the lens or camera.** Doing so could result in loss of vision. Looking at the sun directly through the lens is especially hazardous.
- **Whether it is attached to the camera or not, do not leave the lens under the sun without the lens cap attached.** This is to prevent the lens from concentrating the sun's rays, which could cause a fire.

Handling Cautions

- **If the lens is taken from a cold environment into a warm one, condensation may develop on the lens surface and internal parts.** To prevent condensation in this case, first put the lens into an airtight plastic bag before taking it from a cold to warm environment. Then take out the lens after it has warmed gradually. Do the same when taking the lens from a warm environment into a cold one.
- Do not leave the lens in excessive heat such as in a car in direct sunlight. **High temperatures can cause the lens to malfunction.**

This device complies with Part 15 of the FCC Rules. Operation is subject to the following two conditions: (1) This device may not cause harmful interference, and (2) this device must accept any interference received, including interference that may cause undesired operation.

Do not make any changes or modifications to the equipment unless otherwise specified in the instructions. If such changes or modifications should be made, you could be required to stop operation of the equipment.

This equipment has been tested and found to comply with the limits for a class B digital device, pursuant to part 15 of the FCC Rules. These limits are designed to provide reasonable protection against harmful interference in a residential installation. This equipment generates, uses and can radiate radio frequency energy and, if not installed and used in accordance with the instructions, may cause harmful interference to radio communications.

However, there is no guarantee that interference will not occur in a particular installation. If this equipment does cause harmful interference to radio or television reception, which can be determined by turning the equipment off and on, the user is encouraged to try to correct the interference by one or more of the following measures:

- Reorient or relocate the receiving antenna.
- Increase the separation between the equipment and receiver.
- Consult the dealer or an experienced radio/TV technician for help.

This Class B digital apparatus complies with Canadian ICES-003.

Nomenclature

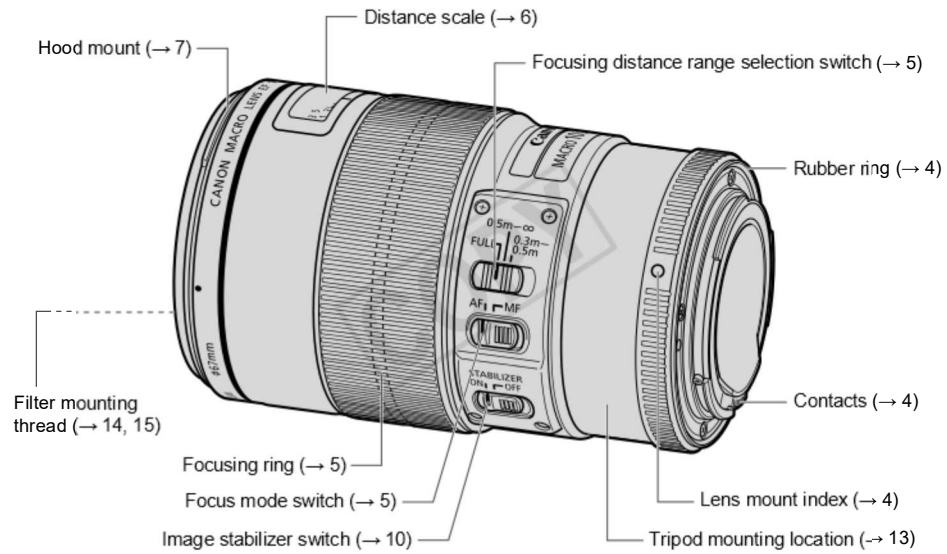

For detailed information, reference page numbers are provided in parentheses (→ **).

1. Mounting and Detaching the Lens

See your camera's instructions for details on mounting and detaching the lens.



- After detaching the lens, place the lens with the rear end up to prevent the lens surface and electrical contacts from getting scratched.
- If the contacts get soiled, scratched, or have fingerprints on them, corrosion or faulty connections can result. The camera and lens may not operate properly.
- If the contacts get soiled or have fingerprints on them, clean them with a soft cloth.
- If you remove the lens, cover it with the dust cap. To attach it properly, align the lens mount index and the K index of the dust cap as shown in the diagram, and turn clockwise. To remove it, reverse the order.



The lens mount has a rubber ring for enhanced water- and dust-resistance. The rubber ring may cause slight abrasions around the camera's lens mount, but this will not cause any problems. If the rubber ring becomes worn, it is replaceable by a Canon Service Center at cost.

2. Setting the Focus Mode

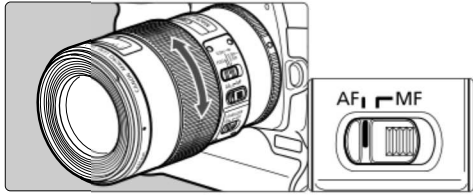

To shoot in autofocus (AF) mode, set the focus mode switch to AF.

To use only manual focusing (MF), set the focus mode switch to MF, and focus by turning the focusing ring. The focusing ring always works, regardless of the focus mode.



After autofocusing in ONE SHOT AF mode, focus manually by pressing the shutter button halfway and turning the focusing ring. (Full-time manual focus)

3. Switching the Focusing Distance Range

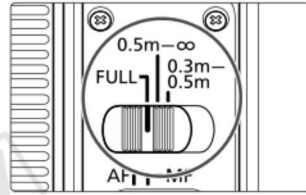

You can switch the focusing distance range to one of three settings: FULL (0.3 m/1.0 ft. to infinity), 0.3 m/1.0 ft. to 0.5 m/1.6 ft., or 0.5 m/1.6 ft. to infinity.

By setting the suitable focusing distance range, the actual autofocusing time can be shorter.

4. Infinity Compensation Mark

Infinity compensation mark

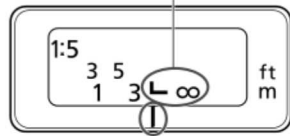

Distance index

To compensate for shifting of the infinity focus point that results from changes in temperature, the infinity position at normal temperature is the point at which the vertical line of the L mark is aligned with the distance indicator on the distance scale.

For accurate manual focusing of subjects at infinity, look through the viewfinder or look at the magnified image* on the LCD screen while rotating the focusing ring.

* For cameras with Live View shooting capability.

5. Hood

The ET-73 hood can keep unwanted light out of the lens, and also protects the lens from rain, snow, and dust.

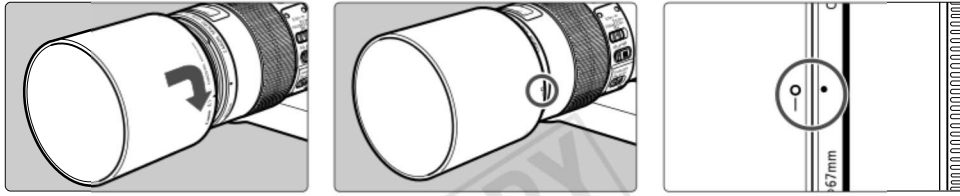

To attach the hood, align the hood's attachment position mark with the red dot on the front of the lens, then turn the hood as shown by the arrow until the lens' red dot is aligned with the hood's stop position mark.

The hood can be reverse-mounted on the lens for storage.

- Part of the picture may be blocked if the hood is not attached properly.
- When attaching or detaching the hood, grasp the base of the hood to turn it. To prevent deformation, do not grasp the rim of the hood to turn it.
- Remove the hood when using the macro flash.

6. Picture Taking

Normal Photography

The lens can be used as a medium-telephoto lens for normal photography such as portraits.

Closeup Photography

Close-up photos up to 1x (life-size) magnification are possible. The minimum focusing distance of 30 cm is the distance from the subject to the focal plane. The working distance from the front of the lens to the subject is about 14 cm.

For normal close-up shooting, the higher the magnification, the faster the shutter speed must be to prevent blur caused by camera shake. Although it depends on the shooting conditions, usually the shutter speed must be at least one or two stops faster than normal.

For a shooting magnification of 0.5x, this lens provides the effect of a shutter speed faster by about three stops. For 1x, it will be about two stops faster.*

* Depending on shooting conditions.

 Since macro shots have a very shallow depth of field, focus carefully to obtain proper sharpness.

- 
- The magnification refers to the ratio between the subject's size and the corresponding image size on the focal plane. On the distance index, it is indicated as 1.x.
 - To check the depth of field, press the camera's depth-of-field preview button.

7. About Exposure

Setting the Exposure

When taking photographs using TTL metering, no exposure compensation is necessary to meter the light coming through the lens.

With TTL metering, AE (autoexposure) is possible at all focusing distances. Just set the desired picture-taking mode, then check the shutter speed and aperture before taking the picture.

Magnification and Effective f-number

The aperture displayed by the camera assumes that the focus is set to infinity. The actual aperture (effective f-number) becomes darker (effective f-number increases) at closer focusing distances (magnification increases). This does not cause exposure problems for normal picture-taking. However, for closeup photography, you cannot ignore the change in the effective f-number.

When you use a handheld exposure meter to set the exposure, you must take into account the exposure factor shown in the following table.

Magnification	1 : 5	1 : 3	1 : 2	1 : 1.5	1 : 1
Effective f/No.	3.6	4.1	4.6	5.0	5.9
Exposure Factor	$+\frac{2}{3}$	+1	$+\frac{1}{3}$	$+\frac{2}{3}$	+2
(stops)*	$+\frac{1}{2}$	+1	$+\frac{1}{2}$		+2

* Upper values: 1/3 stops. Lower values: 1/2 stops.



- The correct exposure for a close-up shot largely depends on the subject. Therefore, try to bracket the exposure for the same subject.
- Using aperture-priority AE (**Av**) or Manual (**M**) picture-taking modes are recommended for macro photography as it is easy to adjust depth of field and exposure in these modes.

8. Image Stabilizer

You can use the image stabilizer in AF or MF mode.

This function provides optimal image stabilization depending on shooting conditions (such as shooting still subjects and following shots).

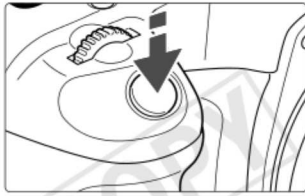
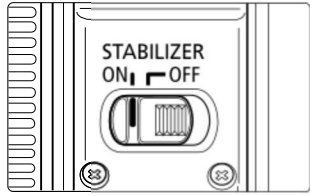

ON



OFF

1 Set the **STABILIZER** switch to **ON**.

- If you are not going to use the image stabilizer function, set the switch to **OFF**.

2 When you press the **shutter button halfway**, the **Image Stabilizer will start operating**.

- Make sure the image in the viewfinder is stable, then press the shutter button the rest of the way down to take the picture.

The image stabilizer in this lens is effective for hand-held shots under the following conditions.

- Close-up shooting.
- In semi-darkened areas such as indoors or outdoors at night.
- In locations where flash photography is prohibited, such as art museums and theater stages.
- In situations where your footing is uncertain.
- In situations where fast shutter settings cannot be used.
- When panning subjects in motion.

Image Stabilizer

- The shorter the subject distance from the camera, the lesser the Image Stabilizer effect will be.
 - The Image Stabilizer cannot compensate for a blurred shot caused by a subject that moved.
 - Set the STABILIZER switch to OFF when you are taking pictures using the Bulb setting (long exposures). If the STABILIZER switch is set to ON, the image stabilizer function may introduce errors.
 - The Image Stabilizer may not be fully effective if you shoot from a violently shaking vehicle or other transportation.
 - The Image Stabilizer consumes more power than normal shooting, so fewer shots can be taken if you use the function.
 - The image stabilizer operates for about two seconds even when your finger is off the shutter button. Do not remove the lens while the stabilizer is in operation. This will cause a malfunction.
 - With the EOS-1V/HS, 3, ELAN 7E/ELAN 7/30/33, ELAN 7NE/ELAN 7N/30V/33V, ELAN II/ELAN IIE/50/50E, REBEL 2000/300, IX, and D30, the Image Stabilizer will not work during self-timer operation.
- When shooting a still subject, it compensates for camera shake in all directions.
 - It compensates for vertical camera shake during following shots in a horizontal direction, and compensates for horizontal camera shake during following shots in a vertical direction.
 - Using a tripod also stabilizes the image. However, depending on the kind of tripod and shooting conditions, sometimes it may be better to turn off the Image Stabilizer function.
 - The stabilizer is equally effective for hand-held photography and photography with a monopod.
 - The image stabilizer function also operates when the lens is used with an Extension Tube EF12 II or EF25 II.
 - Pictures may look distorted after being taken depending on the camera, but this doesn't affect shooting.
 - If you set the camera's Custom Function to change the assigned button to operate the AF, the Image Stabilizer will operate when you press the newly assigned AF button.

9. Taking Hand-held Close-ups

Close-up shots are more prone to be affected by camera shake than with normal shooting. The Image Stabilizer's corrective effect is therefore less during close-ups than during normal shooting even with the same degree of camera shake. The depth of field also becomes very shallow with close-ups, and moving forward or back even slightly will throw off the focus.

When hand-holding the camera for close-up shooting, minimize camera shake and blurred focus with the following techniques:

Hold the camera firmly

As shown on the right, hold the camera firmly so it does not move while shooting.

Use AI Servo AF

For close-up shots, set the camera's AF mode to AI Servo AF. Using autofocus is recommended. The AI Servo AF mode can minimize blurred focus during close-up shooting. For details, see the camera's instruction manual.



Place both elbows on a steady surface such as a table.



Use your knee to support an arm holding the camera.



Lean against a steady object like a wall.

10. Using the Tripod Mount (Sold separately)

Adjusting the Revolving Mount

This lens can be used with the D (B) tripod mount ring, sold separately.

You can loosen the orientation lock-knob on the tripod mount to allow it to rotate as needed to fit a particular camera model for switching between vertical and horizontal positions.

Detaching

Use the following procedures to remove and attach the tripod mount.



1 Turn the locking knob counterclockwise until it becomes loose (about 3 turns), and pull the knob in the direction of the arrow to release the collar.



2 With the collar open, remove the tripod mount.

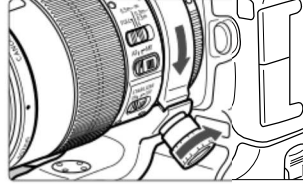

3 To install, while pulling the locking knob, bring the collar to the original position, and tighten the locking knob securely.

 Depending on the EOS camera model, if a battery pack or vertical grip is attached, the tripod mount may bump into it. If that is the case, remove the battery pack/vertical grip or the tripod mount.

 The tripod collar can be attached to or detached from the lens while the lens is attached to the camera.

11. Filters (Sold Separately)

You can attach filters to the filter mounting thread on the front of the lens.

- Filters and the macro flash cannot be used on this lens at the same time.
- If you need a polarizing filter, use the Canon Circular Polarizing Filter PL-C B (67mm).
- To adjust the polarizing filter, first remove the lens hood.

12. Extension Tubes (Sold Separately)

You can attach Extension Tube EF12 II or EF25 II for magnified shots. The shooting distance and magnification are shown below.

	Camera-to-Subject Distance (mm)		Magnification	
	Near	Far	Near	Far
EF12 II	302	1036	1.17×	0.12×
EF25 II	307	591	1.37×	0.27×

 Manual focusing is recommended for accurate focusing.

13. Macro Flash (Sold Separately)

The Canon Macro Ring Lite MR-14EX or the Macro Twin Lite MT-24EX enables fully automatic macro flash photography up to 1x magnification in E-TTL autoflash mode.

Install the Macro Lite Adapter 67 (sold separately) on the filter mounting thread on the front of the lens for macro flash photography.

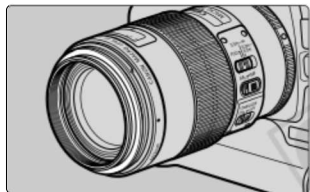

- For information on operating the Canon Macro Ring Lite MR-14EX or the Macro Twin Lite MT-24EX, refer to the individual instruction booklets.
- Using aperture-priority AE (Av) or Manual (M) is recommended.

Specifications

Focal Length/Aperture	100 mm f/2.8
Lens Construction	12 groups, 15 elements
Minimum Aperture	f/32
Angle of View	Diagonal: 24° Vertical: 14° Horizontal: 20°
Min. Focusing Distance	0.3 m/1.0 ft.
Max. Magnification	1 ×
Field of View	24 × 36 mm/0.9 × 1.4 in. (at 0.3 m)
Filter Diameter	67 mm
Max. Diameter and Length	77.7 × 123 mm/3.1 × 4.8 in.
Weight	625 g/22.0 oz.
Hood	ET-73
Lens Cap	E-67U/E-67 II
Case	LP1219
Tripod Collar	Ring-type tripod mounting socket D (B) (Sold separately)

- The lens length is measured from the mount surface to the front end of the lens. Add 21.5 mm to include the E-67U lens cap and dust cap, and 24.2 mm for the E-67 II.
- The size and weight listed are for the lens only, except as indicated.
- The EF1.4X II/EF2X II extenders cannot be used with this lens. There are no compatible close-up lenses.
- Aperture settings are specified on the camera.
- All data listed is measured according to Canon standards.
- Product specifications and appearance are subject to change without notice.

COPY