

**Canon EF LENS**

**EF50mm f/1.2L USM**



**ULTRASONIC**

**ENG**

Instruction

## Thank you for purchasing a Canon product.

The Canon EF50mm f/1.2L USM lens is a high-performance, large-aperture standard lens with a large-diameter, high-precision, aspherical lens element designed for EOS cameras.

The lens is suitable for portraits and other types of photographs making full use of the large-diameter lens feature for nice background blur.

- “USM” stands for Ultrasonic Motor.

### Conventions used in this instruction



Warning to prevent lens or camera malfunction or damage.



Supplementary notes on using the lens and taking pictures.

### Features

1. Large-diameter, high-precision aspheric lens element for excellent imaging performance even at the maximum aperture.
2. Ultrasonic motor (USM) for quick and quiet autofocus.
3. Manual focusing is available after the subject comes into focus in autofocus mode (ONE SHOT AF).
4. A truly round aperture hole results in a nicer background blur.
5. Tight seal structure ensures excellent dust-proof and drip-proof performance.
  - Since the front element of this lens moves when focusing, you need to attach a Canon PROTECT filter sold separately for adequate dust-and water-resistant performance. Without a filter, the lens is not dust or water resistant.

## a Safety Precautions

### a Safety Precautions

- **Do not look at the sun or a bright light source through the lens or camera.** Doing so could result in loss of vision. Looking at the sun directly through the lens is especially hazardous.
- **Whether it is attached to the camera or not, do not leave the lens under the sun without the lens cap attached.** This is to prevent the lens from concentrating the sun's rays, which could cause a fire.

### Handling Cautions

- **If the lens is taken from a cold environment into a warm one, condensation may develop on the lens surface and internal parts.** To prevent condensation in this case, first put the lens into an airtight plastic bag before taking it from a cold to warm environment. Then take out the lens after it has warmed gradually. Do the same when taking the lens from a warm environment into a cold one.
- Do not leave the lens in excessive heat such as in a car in direct sunlight. **High temperatures can cause the lens to malfunction.**

This device complies with Part 15 of the FCC Rules. Operation is subject to the following two conditions: (1) This device may not cause harmful interference, and (2) this device must accept any interference received, including interference that may cause undesired operation.

Do not make any changes or modifications to the equipment unless otherwise specified in the instructions. If such changes or modifications should be made, you could be required to stop operation of the equipment.

This equipment has been tested and found to comply with the limits for a class B digital device, pursuant to part 15 of the FCC Rules. These limits are designed to provide reasonable protection against harmful interference in a residential installation. This equipment generates, uses and can radiate radio frequency energy and, if not installed and used in accordance with the instructions, may cause harmful interference to radio communications.

However, there is no guarantee that interference will not occur in a particular installation. If this equipment does cause harmful interference to radio or television reception, which can be determined by turning the equipment off and on, the user is encouraged to try to correct the interference by one or more of the following measures:

- Reorient or relocate the receiving antenna.
- Increase the separation between the equipment and receiver.
- Consult the dealer or an experienced radio/TV technician for help.

This Class B digital apparatus complies with Canadian ICES-003.

## Nomenclature

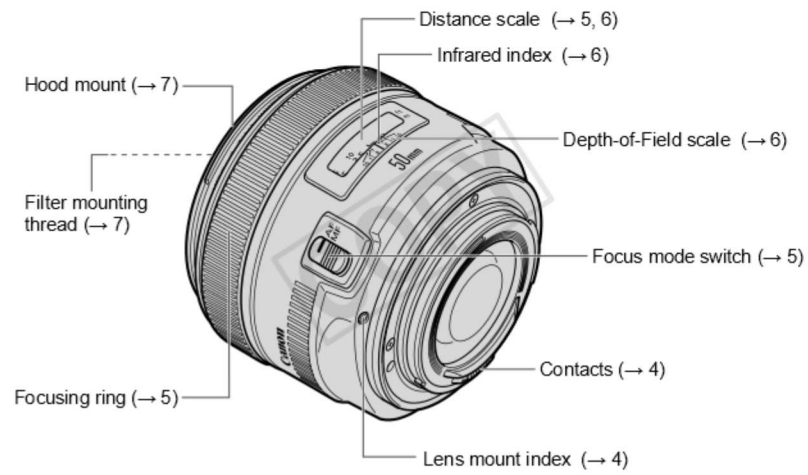

For detailed information, reference page numbers are provided in parentheses (→ \*\*).

## 1. Mounting and Detaching the Lens

See your camera's instructions for details on mounting and detaching the lens.

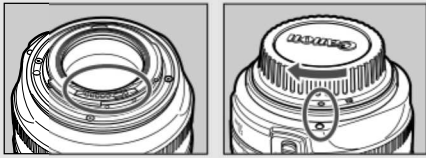

- After detaching the lens, place the lens with the rear end up to prevent the lens surface and electrical contacts from getting scratched.
- If the contacts get soiled, scratched, or have fingerprints on them, corrosion or faulty connections can result. The camera and lens may not operate properly.
- If the contacts get soiled or have fingerprints on them, clean them with a soft cloth.
- If you remove the lens, cover it with the dust cap. To attach it properly, align the lens mount index and the K index of the dust cap as shown in the diagram, and turn clockwise. To remove it, reverse the order.



The lens mount has a rubber ring for enhanced water- and dust-resistance. The rubber ring may cause slight abrasions around the camera's lens mount, but this will not cause any problems. If the rubber ring becomes worn, it is replaceable by a Canon Service Center at cost.

## 2. Setting the Focus Mode

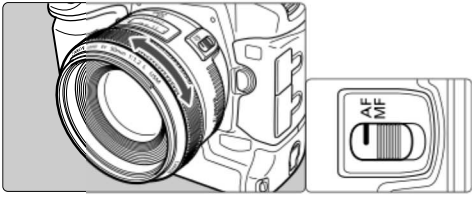

To shoot in autofocus (AF) mode, set the focus mode switch to AF.

To use only manual focusing (MF), set the focus mode switch to MF, and focus by turning the focusing ring. The focusing ring always works, regardless of the focus mode.

 After autofocusing in ONE SHOT AF mode, focus manually by pressing the shutter button halfway and turning the focusing ring. (Full-time manual focus)

## 3. Infinity Compensation Mark

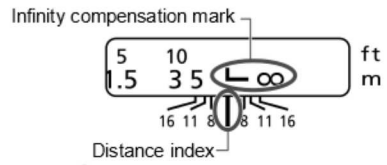

To compensate for shifting of the infinity focus point that results from changes in temperature. The infinity position at normal temperature is the point at which the vertical line of the L mark is aligned with the distance indicator on the distance scale.

 For accurate manual focusing on subjects at infinity distance, look through the viewfinder while rotating the focusing ring.

## 4. Infrared Index

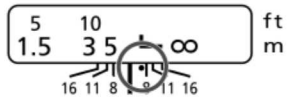

The infrared index corrects the focus setting when using monochrome infrared film. Focus on the subject manually, then adjust the distance setting by moving the focusing ring to the corresponding infrared index mark.

Some EOS cameras cannot use infrared film. See the instructions for your EOS camera.

- The infrared index position is based on a wavelength of 800 nm.
- Be sure to observe the manufacturer's instructions when using infrared film.
- Use a red filter also when you take the picture.

## 5. Depth-of-Field Scale

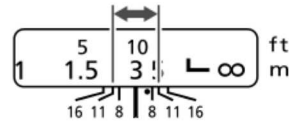

The depth of field is the distance in front of and behind the plane of focus on the subject that appears sharp. The depth of field is indicated by the area between the depth-of-field scale lines below the distance scale. Numbers in the scale are in F values, and for example, if the shooting distance is 3m and the aperture is  $f/11$ , the sharp area will extend from about 2m to 5m.

The depth-of-field scale is an approximate indicator.

## 6. Hood

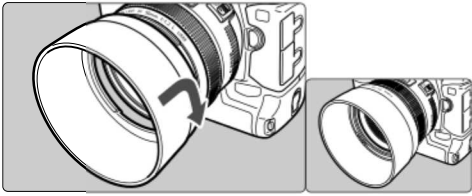

The ES-78 hood can keep unwanted light out of the lens, and also protects the lens from rain, snow, and dust.

Attach and align the hood to the hood mount on the front of the lens, and turn the hood as shown by the arrow to secure it.

The hood can be reverse-mounted on the lens for storage.

- Part of the picture may be blocked if the hood is not attached properly.
- When attaching or detaching the hood, grasp the base of the hood to turn it. To prevent deformation, do not grasp the rim of the hood to turn it.

## 7. Filters (Sold separately)

You can attach filters to the filter mounting thread on the front of the lens.

- To ensure dust- and water-resistant performance, attach a Canon PROTECT filter (72mm).
- Only one filter may be attached.
- If you need a polarizing filter, use the Canon Circular Polarizing Filter (72mm).
- To adjust the polarizing filter, first remove the lens hood.



## 8. Extension Tubes (Sold separately)

You can attach Extension Tube EF12 II or EF25 II for magnified shots. The shooting distance and magnification are shown below.

	Camera-to-Subject Distance (mm)		Magnification	
	Near	Far	Near	Far
EF12 II	246	322	0.39×	0.24×
EF25 II	204	218	0.67×	0.53×

 Manual focusing is recommended for accurate focusing.

## 9. Close-up Lenses (Sold separately)

Attaching a 500D (72mm) Close-up Lens enables close-up photography. Magnification will be 0.25× – 0.10×.

-  • Close-up Lens 250D cannot be attached because there is no size that fits the lens.  
• Manual focusing is recommended for accurate focusing.

## Specifications

<b>Focal Length/Aperture</b>	50 mm f/1.2
<b>Lens Construction</b>	6 groups, 8 elements
<b>Minimum Aperture</b>	f/16
<b>Angle of View</b>	Diagonal: 46°    Vertical: 27°    Horizontal: 40°
<b>Min. Focusing Distance</b>	0.45 m / 1.5 ft.
<b>Max. Magnification</b>	0.15 ×
<b>Field of View</b>	164 × 250 mm / 6.5 × 9.8 inch (at 0.45 m)
<b>Filter Diameter</b>	72 mm / 2.8 inch
<b>Max. Diameter and Length</b>	85.8 × 65.5 mm / 3.4 × 2.6 inch
<b>Weight</b>	590 g / 20.8 oz
<b>Hood</b>	ES-78
<b>Lens Cap</b>	E-72U/E-72 II
<b>Case</b>	LP1214

- ‡ The lens length is measured from the mount surface to the front end of the lens. Add 21.5 mm to include the E-72U lens cap and dust cap, and 24.2 mm for the E-72 II.
- ‡ The size and weight listed are for the lens only, except as indicated.
- ‡ The EF1.4X II/EF2X II extenders cannot be used with this lens.
- ‡ Aperture settings are specified on the camera.
- ‡ All data listed is measured according to Canon standards.
- ‡ Product specifications and appearance are subject to change without notice.

COPY