

Mod. RC 80 P - 100 P Lux Cosmobeam 800 W / 1000 W su pinza

Nato per soddisfare le esigenze del settore noleggio, laddove leggerezza e robustezza sono le caratteristiche peculiari, questo nuovo modello della linea Cosmobeam è stato realizzato in lega ultra leggera. La verniciatura della calotta è ad alta temperatura, mentre la parabola interna è in alluminio satinato ad alta riflettività. Illuminatore a fuoco variabile con movimento morbido e preciso il cui fascio di luce è particolarmente uniforme in posizione flood e di ottima potenza in posizione spot. Il buon rapporto peso/potenza, unito ad un ottimo prezzo lo rende protagonista in molti nostri kit. Tutti gli accessori sono intercambiabili con la gamma tradizionale Cosmobeam. Fornito completo di attacco a pinza, mt. 3,5 cavo a norma VDE fire resistant e interruttore passante da 10 Ah protetto da guscio antiurto.

Mod. RC 80 P - 100 P Lux Cosmobeam 800 W / 1000 W on clamp

Beside the traditional Cosmobeam, a new range has been designed to meet location's requirements. Its light alloy housing is particularly suitable where lightness and ruggedness are required. High temperature finished it has a properly designed reflector, made of polished aluminium that ensures a high degree of reflectivity. Variable beam luminaire with an extremely smooth and accurate focusing mechanism, allows a particularly even illumination and an excellent power through all the working position. The good ratio weight/power together with a competitive price enable this unit to be ideal in many of our kits. All accessories are fully interchangeable with the traditional Cosmobeam range. It is supplied complete with clamp, 3.5 mt. VDE fire resistant cable and in-line 10 Ah switch protected by a high impact-proof housing.

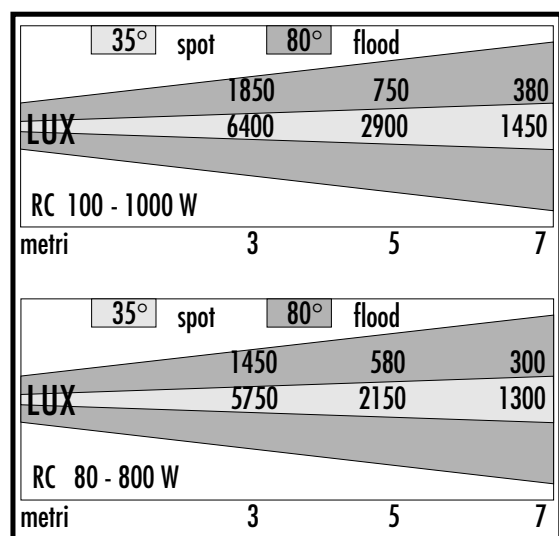
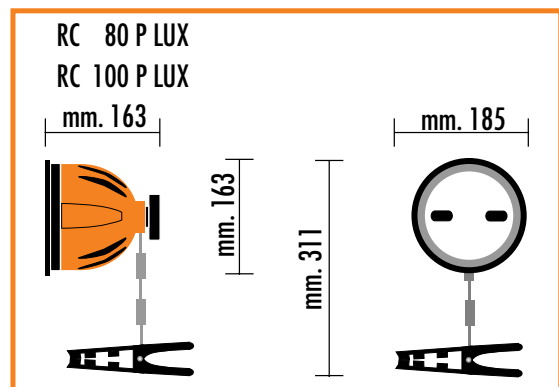







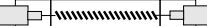





Imballo
Box 27 x 21 x h. 17 cm.

RC 80
Kg. 1,500
RC 100

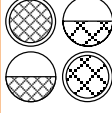
Lampade alogene - attacco R 7S - 3200° K
(Linear tungsten-halogen bulb)

RC 80  800 W - 220 V - 80 mm.
RC 100  1000 W - 220 V - 93 mm.

		gr.
	RC 101 supporto accessori accessory holder	350
	RC 103 paraluce a 4 sportelli four-leaf barndoor	610
	RC 103C paraluce a 4 sportelli con clips portagelatina four-leaf barndoor with gel filter clips	625
	RC 103R paraluce a 4 sportelli con rete inox di protezione four-leaf barndoor with inox wire mesh	635
	RC 103CR paraluce a 4 sportelli con rete inox e clips portagelatina four-leaf barndoor with inox wire mesh and gel filter clips	650
	RC 104 filtro di conversione dichroic filter	170
	RC 105 vetro di sicurezza safety glass	210
	RC 105A vetro diffusore diffusion glass	170
	RC 106 set di reti di filtro (4 pezzi) scrim set (4 pieces)	150
	RC 107 rete inox di protezione (esclude ogni altro accessorio) inox wire mesh (excluding any other accessories)	110
	RC 108 bank diffusore 50 x 50 cm. soft light boxes 50 x 50 cm.	580
	RC 50/55 cono apertura 55 mm. snoot (front diameter 55 mm.)	200
	RC 50/63 cono apertura 63 mm. snoot (front diameter 63 mm.)	210



Mod. RC 80 F - 100 F Lux Cosmobeam 800 W / 1000 W su forcella

Nata per soddisfare le esigenze del settore noleggio, laddove leggerezza e robustezza sono le caratteristiche peculiari, questo nuovo modello della linea Cosmobeam è stato realizzato in lega ultra leggera. La verniciatura della calotta è ad alta temperatura, mentre la parabola interna è in alluminio satinato ad alta riflettività. Illuminatore a fuoco variabile con movimento morbido e preciso il cui fascio di luce è particolarmente uniforme in posizione flood e di ottima potenza in posizione spot. Il buon rapporto peso/potenza, unito ad un ottimo prezzo lo rende protagonista in molti nostri kit. Tutti gli accessori sono intercambiabili con la gamma tradizionale Cosmobeam. Fornito completo di attacco a forcella, mt. 3,5 cavo a norma VDE fire resistant e interruttore passante da 10 Ah protetto da guscio antiurto.

Mod. RC 80 F - 100 F Lux Cosmobeam 800 W / 1000 W on yoke

Beside the traditional Cosmobeam, a new range has been designed to meet location's requirements. Its light alloy housing is particularly suitable where lightness and ruggedness are required. High temperature finished it has a properly designed reflector, made of polished aluminium that ensures a high degree of reflectivity. Variable beam luminaire with an extremely smooth and accurate focusing mechanism, allows a particularly even illumination and an excellent power through all the working position. The good ratio weight/power together with a competitive price enable this unit to be ideal in many of our kits. All accessories are fully interchangeable with the traditional Cosmobeam range. It is supplied complete with yoke, 3.5 mt. VDE fire resistant cable and in-line 10 Ah switch protected by a high impact-proof housing.

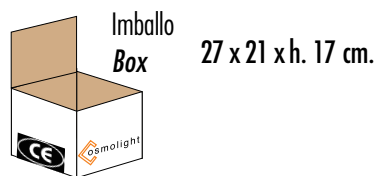
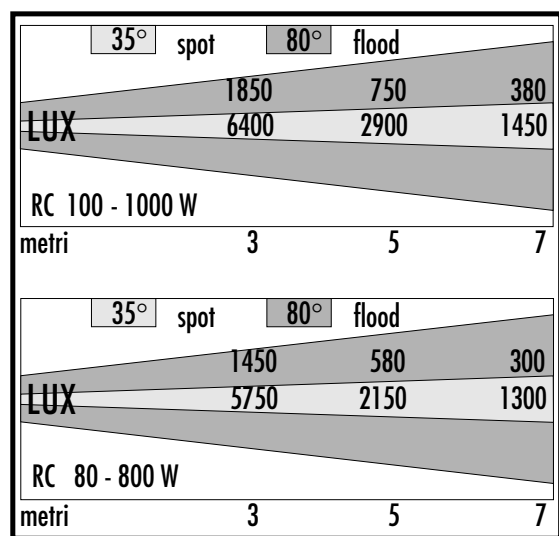
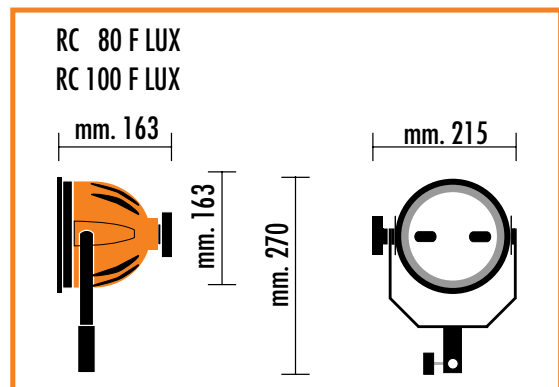

Lampade alogene - attacco R 7S - 3200° K (Linear tungsten-halogen bulb)	
RC 80	800 W - 220 V - 80 mm.
RC 100	1000 W - 220 V - 93 mm.

	RC 101	supporto accessori accessory holder	350
	RC 103	paraluce a 4 sportelli four-leaf barndoor	610
	RC 103 C	paraluce a 4 sportelli con clips portagelatina four-leaf barndoor with gel filter clips	625
	RC 103 R	paraluce a 4 sportelli con rete inox di protezione four-leaf barndoor with inox wire mesh	635
	RC 103 CR	paraluce a 4 sportelli con rete inox e clips portagelatina four-leaf barndoor with inox wire mesh and gel filter clips	650
	RC 104	filtro di conversione dichroic filter	170
	RC 105	vetro di sicurezza safety glass	210
	RC 105 A	vetro diffusore diffusion glass	170
	RC 106	set di reti di filtro (4 pezzi) scrim set (4 pieces)	150
	RC 107	rete inox di protezione (esclude ogni altro accessorio) inox wire mesh (excluding any other accessories)	110
	RC 108	bank diffusore 50 x 50 cm. soft light boxes 50 x 50 cm.	580
	RC 50/55	cono apertura 55 mm. snoot (front diameter 55 mm.)	200
	RC 50/63	cono apertura 63 mm. snoot (front diameter 63 mm.)	210

