

ProHD

DT-N17F

17.3" Broadcast Studio LCD Monitor



HIGHLIGHTS

Supports 3G/HD/SD-SDI and 2K-SDI

DT-N17F supports up to 3G-SDI (SMPTE 425M) including Level-A and Level-B, which are capable of transferring 1080p uncompressed digital video data at a max rate of 60fps at 3Gbit/s. 2K-SDI (2048x1080p) is also supported to downsample to full HD display.

Full HD LCD panel with LED backlighting

The monitor features a 1920x1080 pixel full HD resolution LCD panel with LED backlighting, with 160° wide viewing angle (horizontal and vertical), 700:1 contrast, and 16.7M color depth.

ITU-709 color space

The DT-N17F is compatible with ITU-709 standard color space for HDTV broadcasting.

Selectable gamma preset

The DT-N17F supports gamma preset selection from: 2.2, 2.4 and 2.6.

TSL UMD control and display

The DT-N17F monitor supports UMD controlling input via RS485 and RS232 port, compatible with TSL 3.1 and 4.0 UMD protocol.

USB firmware upgradable

The Monitor offers a USB port on the rear side, for monitor firmware upgrade. Users can download firmware from official website to a USB stick, and the upgrade operation is directly on the monitor, without PC or other adaptors.

Other features

- SDI Timecode (LTC, VITC1&2) and AFD info display
- R/G/B/Mono, False color, Zebra stripes display
- Peaking focus assist display mode
- H/V delay, freeze frame display mode
- Safety area selection: 80%, 85%, 90%, 93%, 95%
- Scale marker: 4:3, 13:9, 14:9, 15:9, 1.85:1, 2.35:1
- Native scan, over scan and normal scan selection
- GPI control via RS485 port connection
- 3 User setting data storage
- TALLY light with adjustable brightness
- 4 User definable function keys
- Easy One-key Menu operation
- Built-in speaker (2.5W, 8Ω)
- Anton Bauer plate for field application

Built-in waveform monitor

The DT-N17F supports waveform selection display (Y, Cb, Cr, R, G, B), and also supports single lines waveform display. The waveform pattern position can be selected from one of four corners and center in larger size. And waveform display color can be selected from white, green and false color, with the transluence also selectable.



Y, Cb, Cr, R, G, B selection display

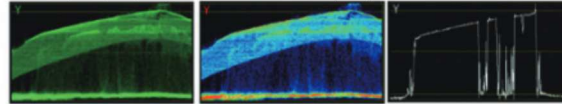

Color selection and single line mode



Display position selection: four corners and large center, with adjustable transluence

Built-in vector scope and histogram monitor

The DT-N17F supports vector scope and R/G/B/Y histogram display. The vector scope colors can be selected from white, green and false color, and the position of the patterns can be selected from one of four corners and the translucent is also selectable.

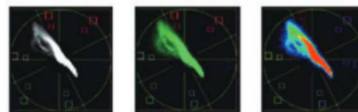

Vector color selection

Translucent adjustment

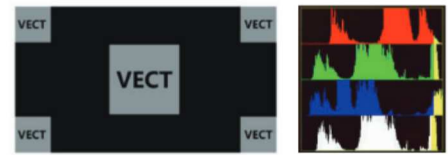

Position selection

R/G/B/Y histogram

16-ch audio level meters with alert and output selection

The monitor can de-embed audio from SDI and HDMI, and display 16-ch audio level meters, with audio abnormal alerts info displayed on each audio bar. You can also select any 2 channels audio to output via 3.5mm socket or speakers. The audio meter pattern position can be selected from one of four corners, and you can select to display only 2 channels, 8 channels, and full 16 channels. Also scale markers, alert info, and translucent of the audio meter pattern are selectable.

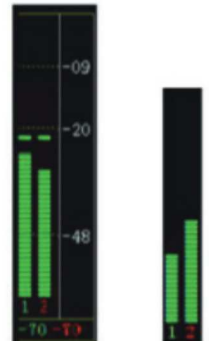
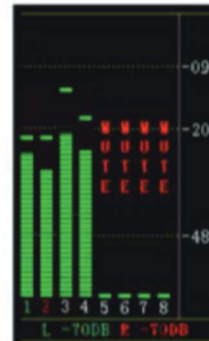
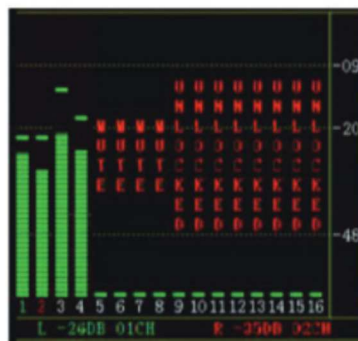

16 ch / 8 ch / 2 ch display mode selection, audio alert on/off, markers on/off



Rear Terminals

- RS-485 ×2.....UMD input and output
- RS-485 ×1.....GPI input
- BNC ×3.....Y/Pb/Pr input
- BNC ×2.....CVBS input and loop output
- RS-232C ×1.....UMD input
- VGA ×1.....VGA input
- HDMI-A ×2.....HDMI input and loop output
- BNC ×2.....SDI 1 input and loop output
- BNC ×2.....SDI 2 input and loop output
- RCA ×2.....Analog audio L and R input
- USB ×1.....USB firmware upgrade

Compatible video formats

CVBS	NTSC / PAL
Y/Pb/Pr	480i, 480p, 576i, 576p, 720p (50 / 60), 1080i (50 / 60)
HDMI	480i / 576i / 480p / 576p
	1080i (60 / 59.94 / 50)
	720p (60 / 59.94 / 50)
	1080p (60 / 59.94 / 50 / 30 / 29.97 / 25 / 24 / 23.98)
SDI	2K
	2048×1080p (24 / 24sF / 23.98 / 23.98sF)
	SMPTE-425M
	1080p (60 / 59.94 / 50)
	SMPTE-274M
	1080i (60 / 59.94 / 50)
	1080p (30 / 29.97 / 25 / 24 / 23.98)
SMPTE-RP211	
1080psf (30 / 29.97 / 25 / 24 / 23.98)	
SMPTE-296M	
720p (60 / 59.94 / 50)	
SMPTE-125M	
480i (59.94)	
ITU-R BT.656	
576i (50)	
VGA	640×480, 800×600, 1024×768, 1152×864, 1280×768, 1280×960, 1280×1024, 1600×1200

Specifications

LCD Display	
Size	17.3 inches wide format
Display area	382mm×215mm
Resolution	1920×1080 (Full HD)
Color depth	16.77 million
Aspect ratio	16:9
Brightness	300cd/m2
Contrast	700:1
Viewing Angle	160°(H) / 160°(V)
Surface treatment	Non-glass
Backlighting	LED
General	
Working voltage	DC / battery 11V-17V
Power consumption	Max 32W
Working temperature	0°C - +40°C
Working humidity	10% - 90%
Storage temperature	- 15°C - + 60°C
Storage humidity	10% - 90%
VESA standard	100mm×100mm (M4×4mm screw)
Dimensions	430×310×52mm
Net weight (w/o stand)	4.7 Kg

External dimensions

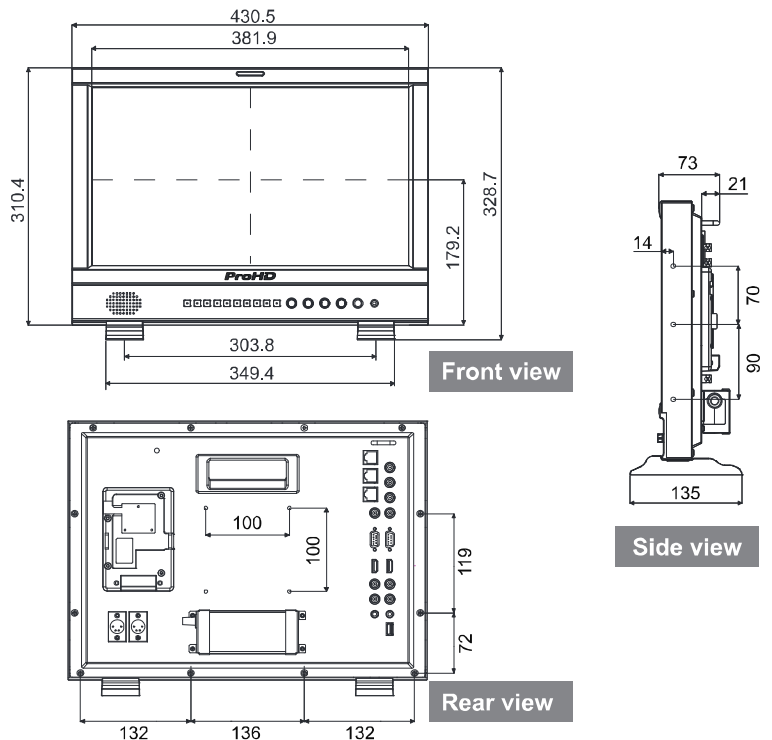

E. & O.E. Design and specifications subject to change without notice
 Copyright 2016, JVCKENWOOD Corporation. All Rights Reserved.
 Manufactured by SWIT Electronics Co., Ltd.

Distributed by: