

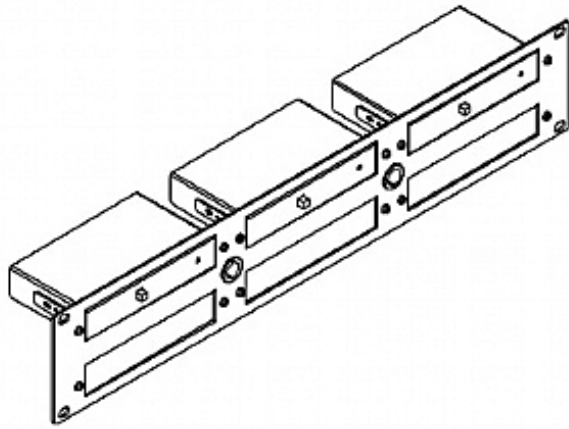

RK-6T

19-Inch Rack Adapter for TOOLS™



19-inch rack adapter for mounting 6 Kramer TOOLS™ into a 2U rack space.



RK-6T

FEATURES

- **Compatibility** - Models compatible with the RK-6T are also compatible with racks: RK-3T, RK-9T, RK-1T2PT, RK-2T1PT & RK-T2SB.