

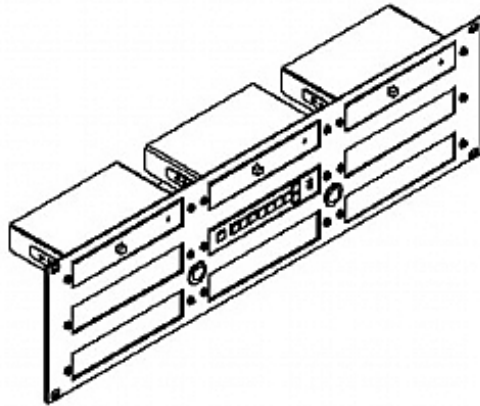

RK-9T

19-Inch Rack Adapter for TOOLS™



19-inch rack adapter for mounting 9 Kramer TOOLS™ into a 3U rack space.



RK-9T

FEATURES

- **Compatibility** - Models compatible with the RK-9T are also compatible with racks: RK-3T, RK-6T, RK-1T2PT, RK-2T1PT & RK-T2SB.