

System	RHP75 (Head) + RT50C (Tripod) + BR-6B (Mid-level spreader) + FP-2B (Large rubber feet) + RC-70 (Carrying case)		
Payload	17 kg / 37.5 lb	Tilt angle	+90° / -70° (Limited to ±40° with maximum counterbalance)
Weight	7.3 kg / 16.1 lb	Pan angle	360°
Height	① H: 1735 mm W: 900 mm (※Reference)	Counterbalance	Range : 5.5~14 kg / 12~31 lb (CG125mm)
	② H: 850 mm W: 670 mm (")		System : Continuous
Folded length	③ L: 915 mm (")	Drag mode	7 STEP
Camera plate (Sliding range)	Sliding plate ±55 mm / 2.2"	Ball diameter	∅100 mm
Plate attachment (Screw sliding range)	Type : 3/8-16UNC × 2	Section	2STAGE (Material : Carbon)
	102 mm / ±4"	Tripod fixation	Fixing lock knob
Spare screw	Type : 3/8-16UNC × 1	Spreader	BR-6B (Telescopic, Removable)
	Equipped on the head (Behind the platform of sliding plate)	Pan handle	PH-8B
		Case material	Nylon , Polyester , TPE , PE , PP

Remarks

■ Exterior Dimensions (mm)

■ RHP75

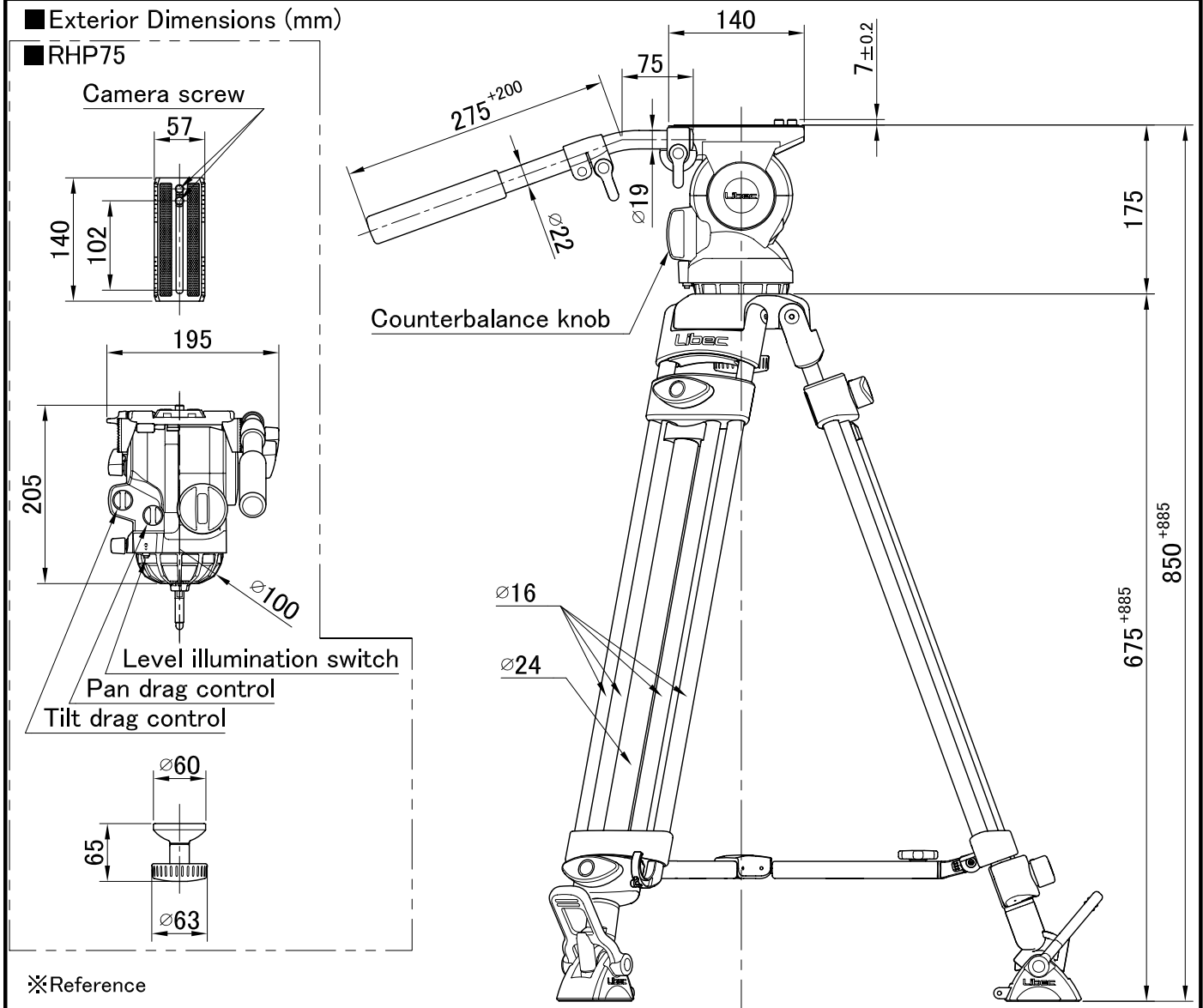

※Reference

