

SONY
make.believe



NEX-FS700

Super Slow Motion NXCAM Camcorder

Push the Boundaries.

Sony is pushing the creative boundaries once more with the new NEX-FS700 Full-HD Super Slow Motion NXCAM camcorder, the latest in Sony's line-up of NXCAM interchangeable E-mount camcorders. Its new 11.6M Exmor Super35 CMOS sensor delivers full-HD quality motion pictures at a maximum of 240 frames per second (fps). This camcorder also features a range of capabilities including built-in ND filters, 3G HD-SDI output, and CineGamma curves that you can intercut with Sony CineAlta™ camera footage. So whenever you're ready to push the boundaries, the NEX-FS700 is ready for you.

NXCAM

AVCHD
Progressive

MPEG2 SD

Exmor™
Super35 CMOS

MEMORY STICK™

SD™
XC

Incredible Super Slow Motion

240 fps at 1080p; 960 fps maximum

Water splashing, balloons bursting and matches igniting are beautifully revealed thanks to the extraordinary Super Slow Motion of the NEX-FS700. Until now restricted to far more expensive cameras, 120 and 240 frames per second burst recording captures Full HD 1920 x 1080. Playing back at 24 fps yields gorgeous slow motion at 1/5 or 1/10 normal speed. Or choose 480 and 960 fps burst recording (at reduced resolution) for even more creative possibilities.

Burst recording time depends on the frame rate. Different frame rates apply to 60 Hz and 50 Hz modes.

Frame rate (60 Hz)	120 fps	240 fps	480 fps	960 fps
Recording time	16 sec	8 sec	9 sec	19 sec
Frame rate (50 Hz)	100 fps	200 fps	400 fps	800 fps
Recording time	19 sec	9 sec	12 sec	23 sec

The NEX-FS700 Super Slow Motion is made possible by the high-speed readout of Sony's Exmor™ CMOS image sensor design. Because of the sensor's low noise and high sensitivity characteristics, extraordinary lighting is not required.

The NEX-FS700 also enables Full HD Slow and Quick Motion at frame rates of 60, 30, 15, 8, 4, 2 and 1 fps (60 Hz mode) or 50, 25, 12, 6, 3, 2 and 1 fps (50 Hz mode).

High speed shooting means slow motion playback

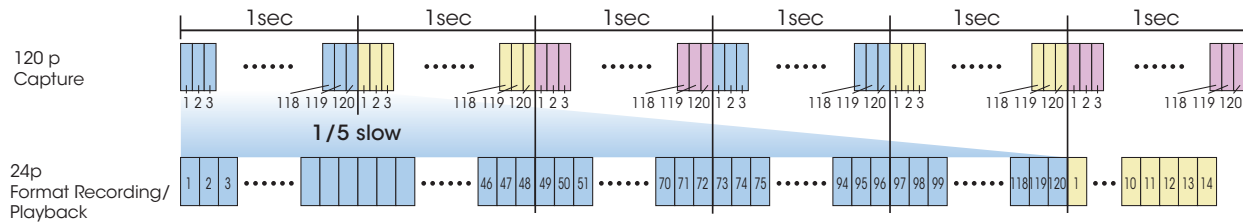

4K Exmor Super35 CMOS Sensor

High speed, high resolution, high sensitivity

At Sony, we're not limited to off-the-shelf image sensors. That's how the NEX-FS700 came to incorporate an innovative Super35 image sensor. With 11.6 million total pixels (4352 x 2662), the sensor provides 4K resolution to enable incredible, oversampled HD today and output a 4K bitstream in the future with a firmware upgrade.

Sony's exclusive Exmor™ technology enables very fast image readout, essential for high speed shooting. The sensor delivers the powerful advantages of the Super 35 image size. You get incredible low-light performance—0.28* lux minimum illumination—and the same depth of field as a Super 35mm motion picture camera. Signal-to-noise ratio is also high.

* 1/30 Shutter, Auto Gain, F1.4. The SEL18200 lens supplied with the NEX-FS700K achieves 1.5 lux (1/30 shutter, Auto Gain, Auto Iris).

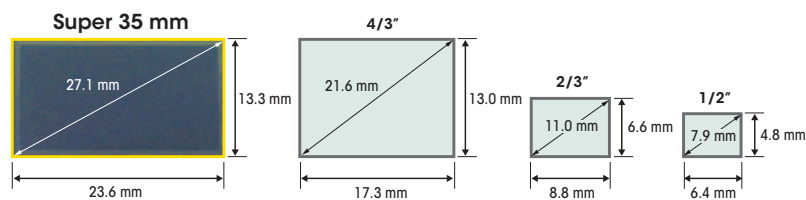

Exmor Super35 CMOS Sensor

Total	Approx. 11.6 Megapixels
Motion Pictures (16:9)	Approx. 8.3 Megapixels effective
Still Pictures (16:9)	Approx. 8.4 Megapixels effective
Still Pictures (3:2)	Approx. 7.1 Megapixels effective



Sensitivity

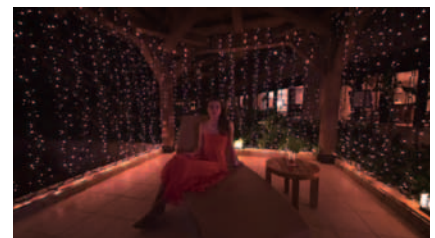
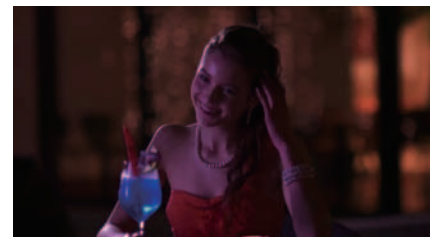

Depth of Field



Interchangeable Lenses

Open to the world

Central to the NEX-FS700 is Sony's E-mount interchangeable lens system. Thanks to an extremely shallow 18 mm flange back distance, the system is uncommonly open to a wide variety of SLR, DSLR and motion picture lenses via third-party adaptors.

E-mount lenses

The growing line of E-mount lenses is light and compact, with aspherical glass elements for high performance, and circular iris mechanisms for beautiful out-of-focus highlights. The SEL18200 (E 18–200 mm F3.5–6.3 OSS) lens supplied with the NEX-FS700K boasts 11x zoom, quiet auto focus, and "Active mode" stabilization for steady handheld shots even as you walk.

A-mount lenses

Sony's LA-EA2 lens adaptor allows you to use over 100 high-quality alpha A-mount lenses and take advantage of the auto focus function for quicker and more convenient operation.

Third-party lenses

The NEX-FS700 accepts motion picture lenses, plus 35mm SLR and DSLR lenses from Canon, Leica, Nikon, Olympus and others via simple third-party adaptors. For amazing creative freedom, you can reach beyond the standard primes and zooms to tilt shift and bellows lenses. Not locked into one type of lens mount or brand, you are free to choose what suits you best.



E-mount lens



A-mount lenses with Sony's LA-EA2 adaptor (sold separately)



SLR and Motion Picture lenses with third party adaptors (sold separately)



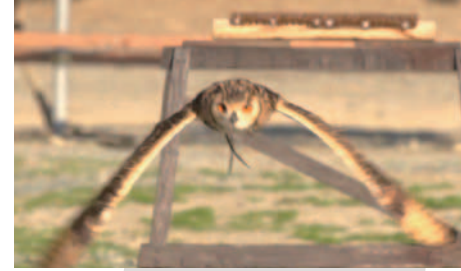
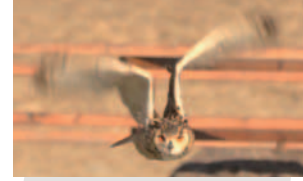
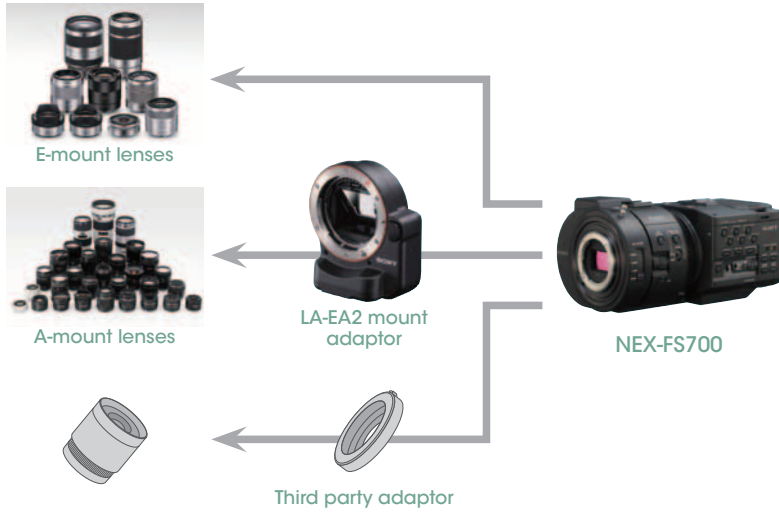

Mount Adaptor LA-EA2 Compatible

The NEX-FS700 can accept A-mount lenses via the LA-EA2 A-mount to E-mount adaptor. Thanks to Translucent Mirror Technology on LA-EA2, auto focus and one push auto iris functions are available during motion picture shooting with most of A-mount lenses.



Mount Adaptor LA-EA2



Translucent Mirror Technology
Translucent Mirror Technology delivers responsive autofocus with A-mount lenses.

Translucent mirror
An innovative translucent mirror simultaneously and continuously transmits light from the lens to both the CMOS image sensor and AF sensor.

AF sensor
Light from the mirror is continuously transmitted to the precision TTL phase detection AF sensor for instant focus lock-on, even with fast-moving subjects.

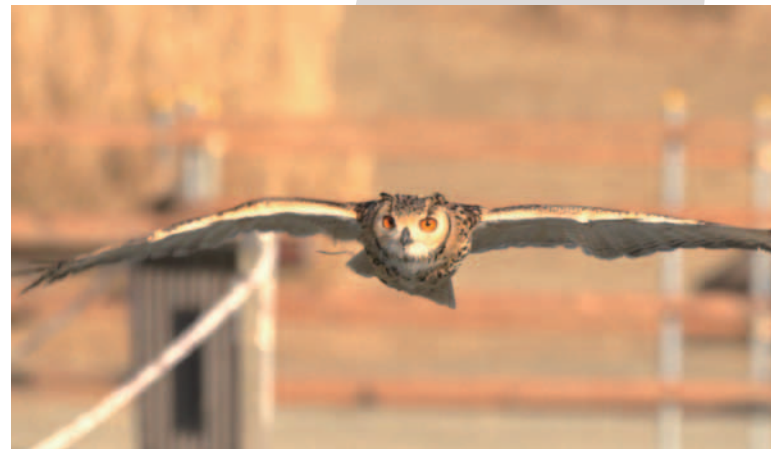
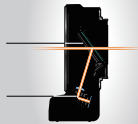

Modular Design

A New Design Concept Provides Flexibility to Build Up New Shooting Styles.

The NEX-FS700 has a refined ergonomic design with a robust detachable handle and an adjustable-angle grip. There are also 1/4-inch and 3/8-inch screw holes on both the top and the bottom of the camera body for mounting various peripheral devices and building various kinds of shooting styles to meet your particular needs. For maximum flexibility, the right side of the FS700 features the industry-standard rosette mount for adding handles and other accessories. Additionally, the camcorder body is equipped with a tape-measure hook and an image sensor position index. Though every switch can be accessed directly, the NEX-FS700 is equipped with a hold switch on the lower side of its body to protect inadvertent setting changes during shooting.



Still Picture Recording

The NEX-FS700 can capture high-quality 8.3M still images with beautiful shallow depth-of-field, thanks to the Exmor Super35 CMOS sensor. The aspect ratio of the still image is selectable from 16:9 to 3:2. This camcorder also includes a face detection function and auto focus, to help ensure subjects are always kept in focus.

Built-in ND Filters

With its built-in, ultra-thin ND filters, the NEX-FS700 offers exceptional shallow depth-of-field on highlights. This means you can expand your shooting styles for many different shooting situations, without requiring external ND filter equipment. The newly designed ND filter wheel rotates across the sensor like a turret. The wheel includes positions for Clear, 1/4 (2 Stop), 1/16 (4 Stop), and 1/64 (6 Stop).

3G HD-SDI and HDMI Output

To supplement the camera's internal AVCHD™ recording, the NEX-FS700 provides uncompressed output to external recorders. Choose HDMI™ output with embedded timecode for 8-bit 4:2:2 signals. Or go with 3G HD-SDI output for easy integration with outboard recorders.

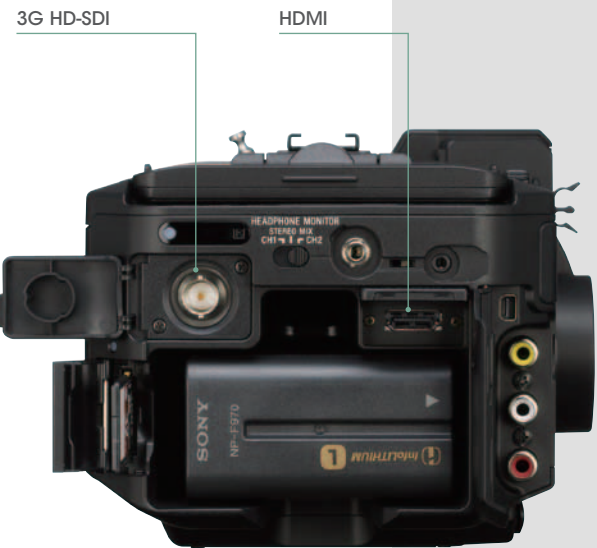

Long loads and hybrid recording

Built-in AVCHD recording

The camera's internal recorder uses the highly efficient AVCHD™ codec for HD recording at bitrates ranging from 5 Mbps (LP mode) to 28 Mbps (PS mode). Standard definition recording is also available using the same MPEG-2 format as DVDs. For greater flexibility, the NEX-FS700 accepts either SD/SDHC/SDXC memory cards (Class 4 and higher), Memory Stick PRO Duo™ cards or Memory Stick PRO-HG Duo™ cards.

Hybrid Recording

For the added security of simultaneous recording and the added flexibility of longer loads, the HXR-FMU128 flash memory unit slips into a slot on the camera and stores 10 hours of HD at the camcorder's highest quality (28 Mbps).

Note: HD and SD cannot be recorded simultaneously.



Recording Time

HD MOVIE

		AVC HD 28M (PS)	AVC HD 24M (FX)	AVC HD 17M (FH)	AVC HD 9M (HQ)	AVC HD 5M (LP)
Linear PCM 2ch	1GB Memory Card	4 min	4 min	6 min	10 min	15 min
	2GB Memory Card	8 min	10 min	10 min	20 min	35 min
	4GB Memory Card	15 min	20 min	25 min	45 min	70 min
	8GB Memory Card	35 min	40 min	55 min	90 min	145 min
	16GB Memory Card	70 min	80 min	110 min	185 min	295 min
	32GB Memory Card	145 min	170 min	225 min	375 min	590 min
	HXR-FMU128 (128GB) [Optional]	600 min	700 min	940 min	1560 min	2460 min
Dolby Digital 2ch	1GB Memory Card	4 min	5 min	7 min	10 min	20 min
	2GB Memory Card	9 min	10 min	10 min	25 min	45 min
	4GB Memory Card	15 min	20 min	30 min	50 min	90 min
	8GB Memory Card	35 min	40 min	60 min	105 min	190 min
	16GB Memory Card	75 min	90 min	120 min	215 min	380 min
	32GB Memory Card	150 min	180 min	245 min	440 min	770 min
	HXR-FMU128 (128GB) [Optional]	640 min	750 min	1030 min	1830 min	3200 min

SD MOVIE

		SD 9M (HQ)
Dolby Digital 2ch	1GB Memory Card	10 min
	2GB Memory Card	25 min
	4GB Memory Card	55 min
	8GB Memory Card	110 min
	16GB Memory Card	225 min
	32GB Memory Card	460 min
	HXR-FMU128 (128GB) [Optional]	1910 min

Note: Recording time may vary depending on recording conditions.



HXR-FMU128 slot

Memory Card slot



Proven workflow

AVCHD recording format

Sony understands that the shoot is just the beginning of your project. Editing and finishing requires reliable workflow. That's why the NEX-FS700 takes advantage of the established AVCHD recording format. AVCHD version 2.0 supports a maximum frame rate of 1920 x 1080/60p (28 Mbps) for exceptional quality.

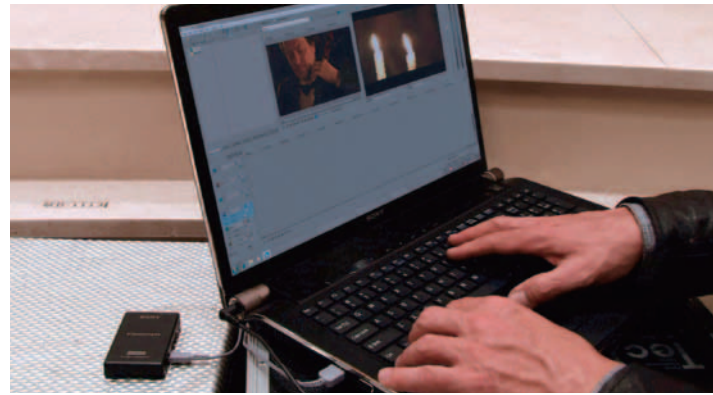

For Windows® users

Use Content Management Utility Software to ingest

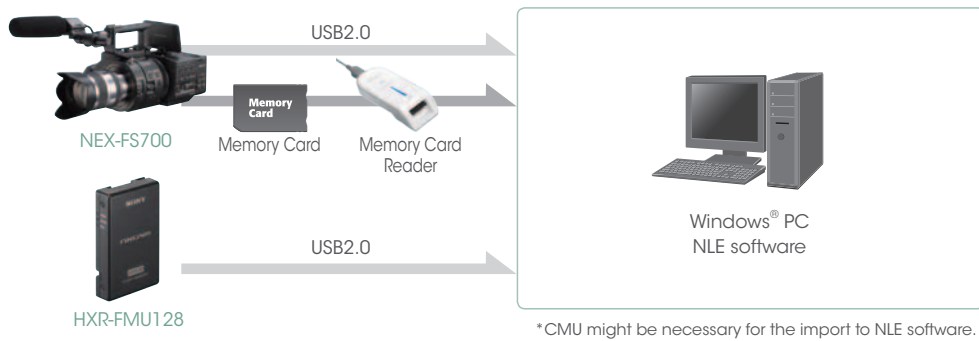

For Final Cut Pro® Users

Use 'Log & Transfer' and convert to ProRes422 to edit

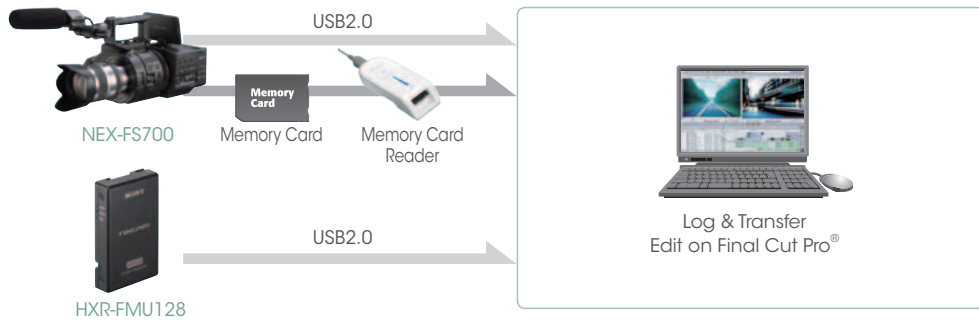

Utilizing HDMI output

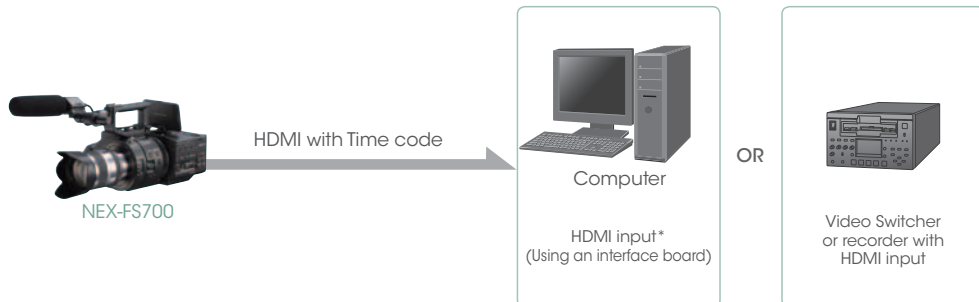

*Please contact the manufacturer for further detailed information

Exquisite creative control

Empower your vision

Expanded Focus

Because focus is critical in HD shooting, the NEX-FS700 provides 4-times and 8-times Expanded Focus magnification plus the ability to move the expanded focus window around the image.

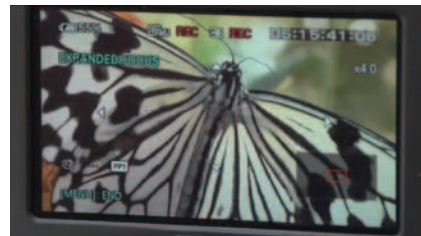

Focus Transition

Sony makes it easier than ever to achieve smooth "rack focus" effects. When using E-mount lenses, you can store start and end focus positions, start time and transition duration. Then simply press Execute to make it happen.



Face Detection in Auto Focus

In auto focus mode, the Face Detection function simplifies operation. When several faces are in frame, you can even assign priority to your star.

Camera Profile Settings Storage on Memory Card

Up to 99 camera-profile settings can be stored, allowing rapid adaptation to multiple shooting environments without time wasted on adjusting parameters. Settings are also easily shared in multicamera productions.

LCD markers

For convenient framing, the camera offers a variety of LCD markers including center, aspect ratio (including 4:3, 13:9, 14:9, 15:9, 1.66:1, 1.85:1 and 2.35:1), safety zone, guide frame, and others. You even have a choice of displaying shutter in degrees or seconds, gain in dB or ISO, and focus distance in meters or feet.

50 Hz/60 Hz World-cam operation

With 50 Hz/60 Hz switching, a single NEX-FS700 can deliver projects for customers anywhere in the world. The camera relieves PAL/NTSC headaches and enables 24p shooting in PAL areas.

Recording Frame rate

HD	PS (28Mbps) 1920 x 1080/60p, 50p
	FX (24Mbps) 1920 x 1080/60i, 50i, 30p, 25p, 24p 1280 x 720 /60p, 50p
	FH (17Mbps) 1920 x 1080/60i, 50i, 30p, 25p, 24p 1280 x 720 /60p, 50p
	HQ (9Mbps) 1440 x 1080/60i, 50i
	LP (5Mbps) 1440 x 1080/60i, 50i
SD	HQ (9Mbps) 720 x 480/60i, 720 x 576/50i

*Recording media formatted or recorded at 60i (50i) cannot be recorded or played back at 50i (60i), and vice versa.

Available Accessories



2NP-F970/B
Rechargeable Battery Pack

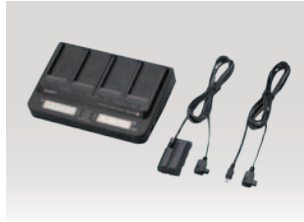

AC-VQL1BP
AC Adaptor / Charger



VCT-SP1BP
Camcorder Support



VCT-SP2BP
Camcorder Support



HXR-FMU128
Flash Memory Unit



VCT-PG11RMB
Tripod with RM-1BP Remote
Controller



HVL-LBPB
Battery Video Light



LPM-770BP
Portable Monitor



LCS-G1BP
Soft Carrying Case



LCS-BP1BP
Soft Carrying Case



RM-1BP
Remote Commander



MS-HX32B (32 GB, 16 GB, 8 GB)
Memory Stick PRO-HG Duo™



SF-32UX (32 GB, 16 GB, 8 GB)
SD/SDHC Memory Card



Specifications

NEX-FS700	
Camera	
Imager	Exmor Super35 CMOS sensor
Number of pixels	Total pixels approx. 11.6M Effective pixels in movie shooting (16:9) approx. 8.3M Effective pixels in still picture shooting (16:9) approx. 8.4M (3:2) approx. 7.1M
Built-in ND filters	Clear, 1/4, 1/16, 1/64
Color temperature	AUTO, ONE PUSH AB, INDOOR (3200K), OUTDOOR (5800K±7 positions), MANU WB TEMP (2300K-15000K, 100K step)
Zoom lens (supplied with NEX-FS700K)	
SEL18200 E mount Lens	Approx. 11x zoom (Optical) f=18-200 mm, 35 mm equivalent 30.6-340 mm (16:9). 34.2-380 mm (3:2) F3.5-6.3 Filter diameter 67 mm Optical Steady Shot installed
Camera system	
Recording format	
Video recording format	HD MPEG-4 AVC/H.264 AVCHD Ver.2.0 SD MPEG-2 PS
Audio recording format	Linear PCM 2ch (48kHz 16-bits) (in HD) Dolby Digital 2ch (48 kHz 16-bits)
Recording mode (Recording bit rate is the total of video and audio)*	
HD	PS max 28 Mbps, 1920 x 1080/60p, 50p, 16:9 FX max 24 Mbps, 1920 x 1080/60i, 50i, 30p, 25p, 24p, 16:9 1280 x 720/60p, 50p, 16:9 FH approx. 17 Mbps (ave), 1920 x 1080/60i, 50i, 30p, 25p, 24p, 16:9 1280 x 720/60p, 50p, 16:9 HQ approx. 9 Mbps (ave), 1440 x 1080/60i, 50i, 16:9 LP approx. 5 Mbps (ave), 1440 x 1080/60i, 50i, 16:9
SD	HQ approx. 9 Mbps (ave), 720 x 480/60i, 720 x 576/50i, 16:9, 4:3
Recording media	Flash Memory Unit (HXR-FMU128) MS PRO Duo (Mark2 only) MS PRO-HG Duo SD/SDHC/SDXC Class4 and higher
Input/output	
Memory card slot	MS PRO Duo, SD/SDHC/SDXC compatible x1
3G HD-SDI OUT	BNC connector x1
HDMI OUT	HDMI connector (type A) x1
COMPONENTOUT	mini D terminal x1
VIDEO OUT	RCA Pin x1
AUDIO OUT	RCA Pin x2
Headphone jack	Stereo mini jack (ø3.5 mm) x1
USB jack	Mini-AB x1
AUDIO INPUT 1/INPUT 2	XLR 3-pin (Female) x2, LINE/MIC/MIC +48V selectable
Remote	Stereo mini-mini jack (ø2.5 mm) x1
LCD screen	
Screen size	8.8 cm (3.5type, 16:9)
Total dots (H x W)	Approx. 921000 dots (1,920 x 480)
General	
Power supply	DC7.2 V (Battery Pack) DC7.6 V (AC-DC adaptor)
Power consumption	9.6 W (60i), 8.8 W (50i)
Operating temperature	32 ~ 104°F (0 ~ 40°C)
Storage temperature	-4 ~ +140°F (-20 ~ +60°C)
Dimensions (W x H x D)	5 3/4 x 7 1/8 x 9 1/4 inches (145.0 mm x 178.5 mm x 235.5 mm) (including protrusions)
Body weight	3 lb 11 oz (1,680 g)
Total weight in recording	6 lb 13 oz (3,060 g) (Mass including SEL18200 [optional], Battery [NP-F770], VF w/ large eyecup, handle, ECM-XM1, grip)
Supplied accessories	
AC Adaptor (AC-PW10), Charger (AC-VL1), Rechargeable Battery Pack (NP-F770), Microphone (ECM-XM1), Remote Commander (RMT-845), Component video cable, A/V connecting cable, USB cable, USB Adaptor Cable (VMC-UAM1), Large eyecup, Lens hood with lens cover (Lens cap & Lens hood), Lithium Battery (CR2025), Clock Lithium (Installed), Application Software (CD-ROM) (CMU2.1)	

* Due to variable bit rate, 28Mbps is the maximum bit rate for HD PS mode, and 24Mbps for HD FX mode. The average bit rate is stated for FH, HQ and LP modes.

Dimensions

NEX-FS700

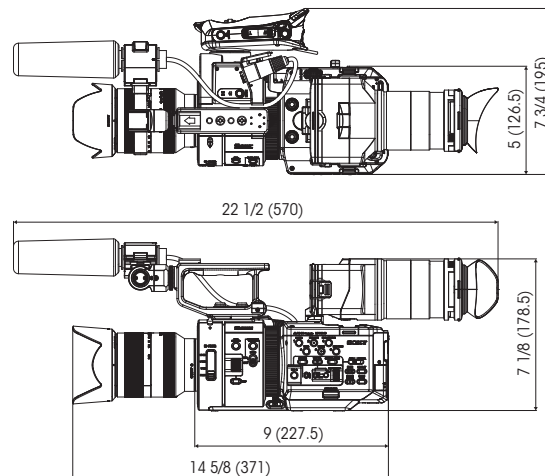

Body only

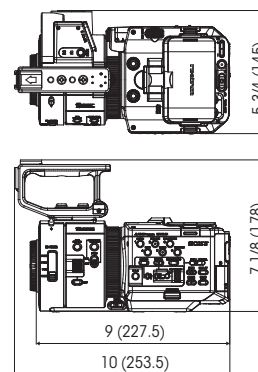

HXR-FMU128

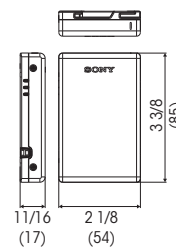

Unit: inches (mm)