

# SONY



Sony's lightweight picture monitor lineup  
from studio to field

## PVM-A Series

Professional OLED Picture Monitor

## LMD-A Series

Professional LCD Picture Monitor

TRIMASTER **EL**

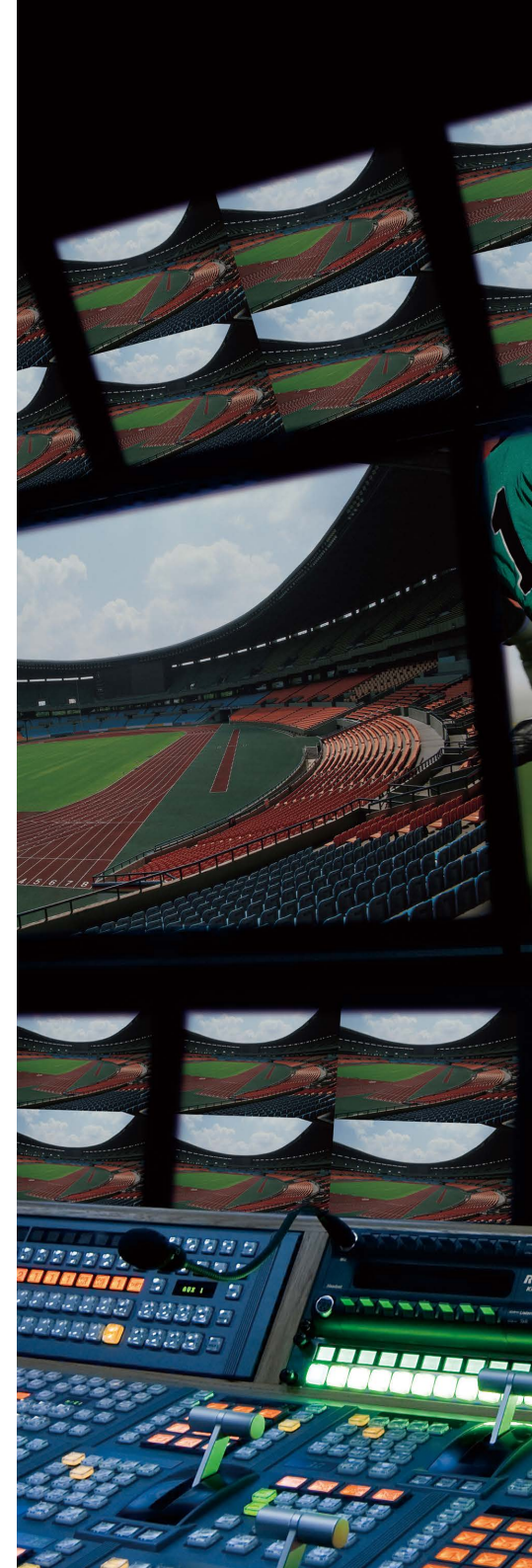



Sony is proud to introduce its lightweight, stylish picture monitor lineup: PVM-A Series TRIMASTER EL OLED picture monitors and LMD-A Series LCD monitors.

### Lightweight and Slim – Easy to Carry

The PVM-A Series includes the PVM-A250 (25-inch) and PVM-A170 (17-inch) monitors, achieving an industry-leading lightweight and slimline body.\*<sup>1</sup> The PVM-A250 weighs 6.1 kg and the PVM-A170 weighs just 4.2 kg, and both are approximately 40% slimmer than previous PVM-41 Series models.

These advantages allow the new PVM monitors to be used in a wider range of applications and reduce associated costs. These monitors are ideal for field monitoring and can be installed on a monitor wall or in an OB van. Now users can experience reliable, high-quality OLED monitoring anytime, anywhere.

Sony's LMD-A Series monitor lineup offers an excellent cost-performance ratio. Models include the LMD-A240 (24-inch), LMD-A220 (22-inch), and LMD-A170 (17-inch).

LMD-A Series monitors deliver full HD resolution, along with a lightweight and compact design. There is more than a 12% to 22% reduction in mass, 30% reduction in depth, and more than 25% reduction in power consumption, compared to Sony's previous models.

The LMD-A Series offers the same user-interface design, convenient features and functions, and operability as PVM-A Series OLED picture monitors. This consistency between the PVM-A and LMD-A Series brings great user benefits when both types of monitor are used in the same environment.

Furthermore, PVM-A and LMD-A Series monitors provide versatility for a wide range of user applications both in the studio and in the field: DC operation\*<sup>2</sup>, VESA-mount and yoke-mount holes, and an optional protection kit.\*<sup>3</sup>

This broad and powerful professional OLED and LCD picture monitor lineup continues to meet the broadest range of application needs for excellent cost-performance picture monitoring.

\*<sup>1</sup> Professional broadcast monitors incorporating SDI interface(s) and built-in AC power.  
\*<sup>2</sup> The PVM-A250 does not support DC operation.  
\*<sup>3</sup> The PVM-A250, PVM-A170, and LMD-A170 only.

#### PVM-A Series



PVM-A250

PVM-A170

PVM-741

#### LMD-A Series



LMD-A240

LMD-A220

LMD-A170

LMD-941W

## Viewing Angle Innovation

The PVM-A250 and PVM-A170 incorporate the TRIMASTER EL OLED panel to offer an industry-leading viewing angle compared with other professional flat-panel monitors available on the market. This enables group monitoring – for example, video engineers or colorists can view the display properly from many different angles – and this allows more efficient content creation activities.

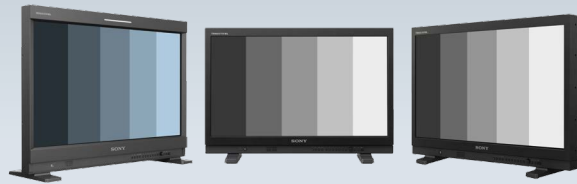

Predecessor models      Front view      PVM-A250 / PVM-A170

\* Simulated images

## New Design Innovation

As well as offering high performance, both the PVM-A250 and PVM-A170 have a new chassis design that fits portable and field applications. The slim design, new handle, and protected connectors are perfect for rental, on set, and light stand applications.



Connector panel



PVM-A250 rear



PVM-A250 side

## Accurate Black Reproduction

A key advantage of TRIMASTER EL is the fact that each pixel can be turned completely off. No other display technology is able to offer this. In comparison, TRIMASTER EL is capable of reproducing accurate black with each individual pixel, enabling users to evaluate each picture image faithfully to the signal.

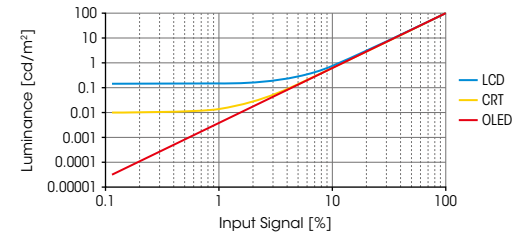

\* Simulated images

## Accurate Color Reproduction

Sony's Super Top Emission technology not only offers a wide color gamut with its purity of the three primary colors, but also maintains this wide color gamut throughout the entire luminance range. TRIMASTER EL system is truly an ideal display device for picture evaluation. With OLED, users see the details in the blacks, and see the colors as well.

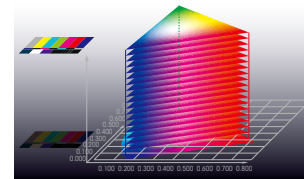

\* Simulated images

\* Color gamut images based on Sony's test results

## Quick Response with Virtually No Motion Blur

The TRIMASTER EL gray-to-gray switching speed (measured in microseconds,  $\mu\text{s}$ ) is much faster than that of the LCD (measured in milliseconds, ms).\* This fast response benefits a variety of applications and uses, for example, in sports broadcasting.

\* Sony's test results.

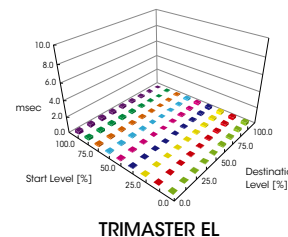

\* Simulated images

# Lightweight Compact Design and Versatility for a Wide Range of User Applications

## Flexible Mounting For Picture Monitoring

PVM-A Series and LMD-A Series monitors incorporate a lightweight, compact body. Their design offers flexibility, and can be adapted according to the application: a desktop unit with standard table feet, or used with an optional SU-561 stand, or without the stand for wall applications. These monitors support VESA mounting with a 100-mm pitch, and EIA 19-inch standard racks. \* This allows the monitors to be used for all types of application – desktop editing, office viewing, used on a studio monitor wall, or installed in OB vans.

\* The LMD-A240 cannot be 19" rack-mountable.



PVM-A250 standard

PVM-A250 with optional SU-561

PVM-A250 without stand

## Optional Protection Kit

This accessory provides an AR-coated protection panel for the PVM-A250, PVM-A170, and LMD-A170 monitor, along with corner bumpers to safeguard the monitor from scratches and impact. The benefit of this is significant when renting out these monitors – for example, panel damage is reduced and there is a far lower incidence of panel replacement and downtime during rental cycles.



LMD-A170 with protection kit image



LMD-A240 with yoke-mount image (3rd vendor yoke mount is required)

## Yoke-mount and VESA-mount Capability

All PVM-A and LMD-A Series monitors have screw holes on their side bezels for yoke mounting. This type of mounting is convenient when installing a monitor to a camera crane or monitor stand. There are also VESA-mount 100-mm pitch holes on each monitor's rear panel.

	PVM-A250	PVM-A170	LMD-A240	LMD-A220	LMD-A170
Standard monitor feet	✓	✓	✓	✓	✓
Optional monitor stand	SU-561	SU-561	SU-561	SU-561	SU-561
VESA mounting (100 x 100 mm)	✓	✓	✓	✓	✓
Yoke mounting*	✓	✓	✓	✓	✓
Rack mount (optional)	MB-L22	MB-P17	-	MB-L22	MB-L17
Protection kit (optional)	BKM-PP25	BKM-PP17	-	-	BKM-PL17

\* 3rd vendor yoke mount is required.

## User-friendly Operability and UI

PVM-A and LMD-A Series monitors offer the same functions and operability. This means that both types of monitor can be operated and controlled in the same way.



Front control panel: Consistent design between the PVM-A and LMD-A Series.

## Input Versatility

PVM-A and LMD-A Series monitors are equipped with built in standard input interfaces: 3G/HD/SD-SDI (x2), HDMI (HDCP) input (x1), and composite (x1). These monitors\*<sup>1</sup> support dual-link HD-SDI to accept up to 1920 x 1080/50p, 60p signals.\*<sup>2</sup> They also support 2048 x 1080/50p, 60p signals.\*<sup>2</sup>

\*<sup>1</sup> The PVM-741 and LMD-941W do not support dual-link HD-SDI and 2048 signals.

\*<sup>2</sup> Supported with V1.1.

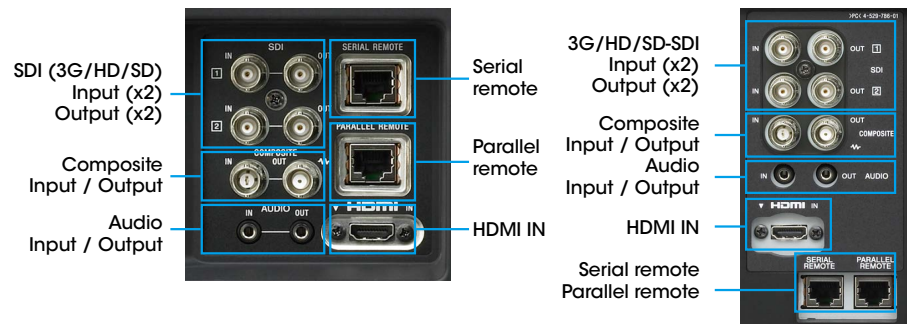

## Optimized Low-latency I/P Conversion

The I/P conversion system delivers automatically optimized signal processing according to input signals with low-latency (less than 0.5 field). This system helps users to edit and monitor for a live production.

## Waveform Monitor and Vector Scope Display

These enable users to monitor sources using the internal waveform and vector scope. These displays also provide some of the same evaluation tools as larger dedicated equipment. Both the waveform monitor and the vector scope offer zoom functions for very precise signal adjustment (from zero to 20% video level). In addition, the waveform monitor includes a line select feature, so users can adjust levels based on individual areas of the screen. Both displays have two-channel audio monitoring. In conjunction with the Picture & Picture function\*, the waveform monitor and vector scope display can monitor two camera signals.

\* Supported with V1.1.



Waveform monitor

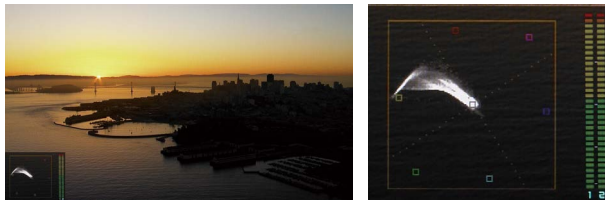

Vector scope

## Camera Focus Function

PVM-A and LMD-A Series monitors can control the aperture level of a video signal, and display images on screen with sharpened edges to help camera focus operation. Further to this, the sharpened edges can be displayed in user-selectable colors (white, red, green, blue, and yellow) for more precise focusing.



Camera focus image

## Line-doubler Mode\* for Field Check

The PVM-A250 and PVM-A170 offer a line-doubler mode which is helpful when checking for line flicker.

\* Supported with V1.1.

## Time code and In-monitor Display (IMD) Function\*

With an external remote function via Ethernet, image source names and tally information can be displayed on screen. LMD-A Series monitors support the TSL system protocol. The IMD system can display European language text including umlaut and accent marks.

\* The PVM-A250, PVM-A170, and PVM-741 do not support IMD function.



Time code and waveform monitor



Time code, on-screen tally, and 93% area marker



IMD on the LMD-A240 16:10 screen

## Auto White Adjustment\*1

PVM-A250, PVM-A170, PVM-741, LMD-A240, LMD-A220, LMD-A170, and LMD-941W monitors employ a software-based color temperature (white balance) calibration function, which is called Monitor\_AutoWhiteAdjustment. Combined with a PC and commercially available calibration tools\*2, this function enables simple adjustment of the monitor's white balance.

\*1 Supported with V1.1.

\*2 The Konica Minolta CA-210/CA-310/CS-200, DK-Technologies PM5639/06, X-Rite i1 Pro/i1 Pro2, Photo Research PR-655/670, Klein K-10, and JETI specbos 1211.

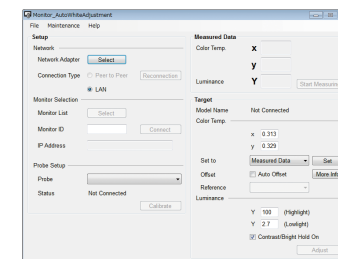

\*Monitor\_AutoWhiteAdjustment\* GUI image

PVM-A Series and LMD-A Series monitors with camera-linkage functions\* provide the convenience of working efficiently both in the field and in the post-process. Their functions include camera metadata display and a Picture and Picture function. Also these monitors provide convenient features that save administrative operating costs, including UserPreset, password lock, and a networking upgrade function.\*

The PVM-A Series and LMD-A Series offer common user interfaces (UIs), so that users can combine these monitors yet achieve the same functionality and operational familiarity across all display types.

\* All functions on this page with an asterisk are supported with V1.1.

## Picture & Picture\*

The unique Picture & Picture function of the PVM-A and LMD-A Series allows simultaneous display of two input signals on the monitor's screen. This function helps with color adjustment and setting of camera frames.

\* This function works when synchronous SDI signals are input.



Side-by-side



Wipe



Blending



Difference

## 2K (2048 x 1080) Input and Image-slide\*

PVM-A and LMD-A Series monitors are capable of 2K (2048 x 1080 resolution) input. The 2K signal is displayed in two ways – as a full 2K image scaled into a full-HD (1920 x 1080) screen, or as a 2K native display with an image-slide function.



## Camera Metadata Display Function\*<sup>1</sup>

PVM-A and LMD-A Series monitors can display the camera and lens metadata set of a camera system, according to the SMPTE RDD-18 document for Acquisition Metadata Sets for Video Camera Parameters. Further to this, these monitors also support a subset of Sony's private metadata.\*<sup>2</sup>

\*<sup>1</sup> Supported with V1.1.

\*<sup>2</sup> Not all metadata is supported.

## Anamorphic Image Conversion\*

PVM-A and LMD-A Series monitors correctly display horizontally squeezed 3G/HD-SDI signals from an onset camera system. The signals include two major systems: 16:9 1920 x 1080 (1280 x 720) signals and 17:9 2048 x 1080 signals. These signals can be appropriately displayed on the monitor's screen.

\* Only 3G/HD-SDI and dual-link HD-SDI are supported.



Native scan image



Normal scan image

## Grid Display\*

This function displays arbitrary multiple vertical and horizontal lines to help when users check the composition of a picture.

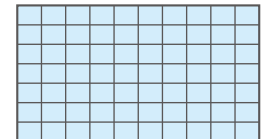

Vertical and horizontal lines

## Center Markers\*

In addition to a standard Center Marker 1, Center Marker 2 is also available. This second marker enables easier checking of the center portion's focus.



Center marker 1



Center marker 2

## Flip Function\*

The Flip function turns the reversed image to a normal view, horizontally or vertically.

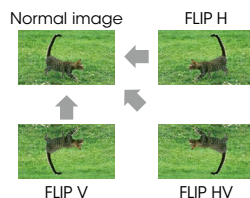

## Multiple Monitors Upgrade Utility\*

Multiple PVM-A and LMD-A Series monitors on the same Ethernet network can be upgraded by simple operation.

## Power-on Setting\*

This function allows users to select setting data when the monitor starts up; this includes last memory, user preset, and factory preset settings. Users can set the monitor accurately and quickly. This function is very useful for rental equipment.

## User Presets\*

When multiple users share the same monitor, each user can memorize his/her setting data and retrieve this data whenever required. This frees the user from time-consuming and repetitive setting tasks.

## Password Lock for User Preset\*

When multiple users share the same monitor, each user can register his/her own password for color temperature and user preset data. This ensures the user correctly recalls previous user preset data, and keeps preset information safe from unauthorized use.

## Short-cut to Function Key Configuration\*

By simply pressing the function key repeatedly, the user can take a short-cut to the settings menu screen.

## USB 2.0 for Power Supply (+5 V, 500 mA)\*

The USB 2.0 port can supply 5 V power to third-party devices.

## On-screen Tally\*

The on-screen tally can display in three colors. The position of the tally display can be changed to either the upper or lower section of the screen.



On-screen tally (upper)



On-screen tally (lower)

## Active Format Description (AFD) Function\*

PVM-A and LMD-A Series monitors read the ancillary data flag on an SDI, and upconvert the SD image to display automatically on the full HD resolution screen. This is achieved by adjusting the resolution and aspect ratio.

\* Only SD-SDI signals are supported.

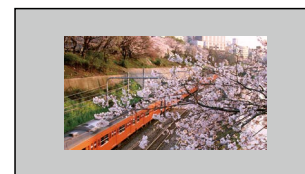

SD image

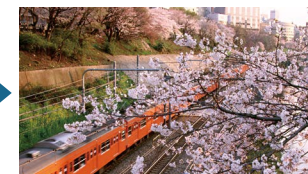

Up-converted image

## DC Low Power Indicator\*

The power indicator blinks when the DC power supply is low.

\* The PVM-A250 does not support a DC power supply.

\* All functions on this page with an asterisk are supported with V1.1.

### Robust, light-weight, and compact body

Incorporating a light-weight and compact aluminum-diecast body with a detachable AR-coated protection panel, this model is flexible enough to change style according to user requirements.



AR-coated protection panel



PVM-741 installed in the optional MB-531 19" mounting bracket with MB-532 mounting panel

### Easy Mounting into A Camera System

With 3/8-inch and 1/4-inch screw holes on its base, the PVM-741 and LMD-941W can be installed in a camera system. Also with the supplied arm-mount bracket fixed on the top, these monitors can be installed in a camera arm.



Rear and bottom



Arm-mount bracket is attached on the top

### Retractable Carrying Handle

A retractable carrying handle is provided as a supplied accessory, allowing users to carry these monitors anytime, anywhere.



PVM-741 with carrying handle

### ENG Kit VF-510

For use in ENG and EFP field, the optional VF-510 ENG Kit provides a viewing hood, carrying handle, and connector protector.



VF-510 ENG Kit



PVM-741

Sony's Super-Top-Emission OLED panel with a 10-bit driver  
960 x 540 pixels resolution



LMD-941W

Full HD (1920 x 1080 pixels) resolution  
IPS LCD panel

\*Simulated images

- Two 3G/HD/SD-SDI and an HDMI input interfaces
- Waveform monitor, Vector scope, Audio level meter, Time code
- Closed caption display
- Camera focus function
- Easy-to-use control panel

## PVM-741 and LMD-941W features



## Camera Focus Function

The PVM-741 and LMD-941W can control the aperture level of a video signal, and display images on the screen with sharpened edges to help camera focus operation. Further to this, the sharpened edges can be displayed in user-selectable colors (white, red, green, blue, and yellow) for more precise focusing. This camera focus function can even be enhanced when combined with native scan mode.



## Waveform Monitor and Vector Scope Display

An input signal's waveform and vector scope with an SDI-embedded 2-channel audio level meter can be displayed on screen. Both the waveform monitor and vector scope have various modes, including a zoom function.

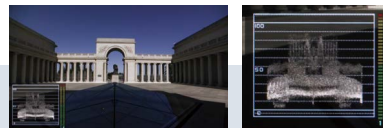

Waveform monitor

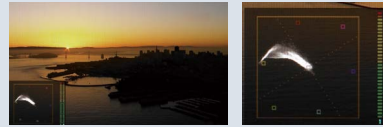

Vector scope

## Input versatility

The PVM-741 and LMD-941W are equipped with built-in standard input interfaces: 3G/HD/SD-SDI (x2), composite (x1), and HDMI input (x1).



## Flip function (PVM-741 only)

The PVM-741 monitor has a feature to flip a picture without frame delay, horizontally, vertically, or horizontally and vertically.

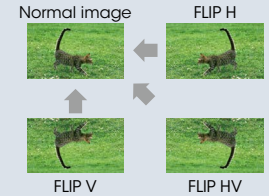

## Easy-to-use control panel design



Input selection buttons

Assignable function buttons Default setting;

F1 (BRIGHTNESS) F2 (CONTRAST)

F3 (CHROMA) F4 (SCAN)

F5 (H/V DELAY) F6 (VOLUME)

F7 (I/P MODE\*)

\*Picture Delay Minimum Mode

Up/down Volume & Enter/set button

Return button

Menu on/off button

## Signal Formats

System	Signal standard				
	Analog composite	SDI			HDMI
		SD/HD	Dual link *5	3G	
575/50i (PAL)	○	○	–	–	○
480/60i (NTSC)*1	○	○	–	–	○
576/50p	–	–	–	–	○
480/60p*1	–	–	–	–	○
640 x 480/60p*1	–	–	–	–	○
1920 x 1080/24PsF*1*2	–	○	○*3	○*3	–
1920 x 1080/25PsF*2	–	○	○*3	○*3	–
1920 x 1080/30PsF*1*2	–	○*5	○*3	○*3	–
1920 x 1080/24p*1	–	○	○*3	○*3	○
1920 x 1080/25p	–	○	○*3	○*3	○
1920 x 1080/30p*1	–	○	○*3	○*3	○
1920 x 1080/50i	–	○	○*3	○*3	○
1920 x 1080/60i*1	–	○	○*3	○*3	○
1920 x 1080/50p	–	–	○*4	○*4	○
1920 x 1080/60p*1	–	–	○*4	○*4	○
1280 x 720/24p*1	–	○	–	–	–
1280 x 720/25p	–	○	–	–	–
1280 x 720/30p*1	–	○	–	–	–
1280 x 720/50p	–	○	–	○*3	○
1280 x 720/60p*1	–	○	–	○*3	○
2048 x 1080/24PsF*1*2*5	–	○	○*3	○*3	–
2048 x 1080/25PsF*2*5	–	○	○*3	○*3	–
2048 x 1080/30PsF*1*2*5	–	○	○*3	○*3	–
2048 x 1080/24p*1*5	–	○	○*3	○*3	–
2048 x 1080/25p*5	–	○	○*3	○*3	–
2048 x 1080/30p*1*5	–	○	○*3	○*3	–
2048 x 1080/48p*1*5	–	–	○*4	○*4	–
2048 x 1080/50p*5	–	–	○*4	○*4	–
2048 x 1080/60p*1*5	–	–	○*4	○*4	–

\*1 Compatible with 1/1.001 frame rates.

\*2 PVM-A/LMD-A Series: 1080/25PsF, 30PsF, 2048/25PsF, 30PsF are displayed as 1080/25PsF, 30PsF, 2048/25PsF, 30PsF on the screen if the Payload ID is added to the video signal, or displayed as 1080/50i, 60i, 2048/50i, 60i if the ID is not added.

PVM-741/LMD-941W: 1080/24PsF, 25PsF, and 30PsF are displayed as 1080/48i, 50i, and 60i on the screen, respectively.

\*3 10-bit 4:4:4 Y/Cb/Cr and 4:4:4 RGB are supported.

\*4 10-bit 4:2:2 Y/Cb/Cr is supported.

\*5 PVM-A250/PVM-A170/LMD-A240/LMD-A220/LMD-A170 only support 1920 x 1080/30PsF; the dual link and 2048 signals. Supported with V1.1.

## Specifications

	PVM-A250	PVM-A170	PVM-741
<b>Picture Performance</b>			
Panel	OLED panel		
Picture size (Diagonal)	623.4 mm (24 5/8 inches)	419.7 mm (16 1/2 inches)	188.0 mm (7 1/2 inches)
Effective picture size (H x V)	543.4 x 305.6 mm (21 1/2 x 12 1/8 inches)	365.8 x 205.7 mm (14 1/2 x 8 1/8 inches)	163.9 x 92.2 mm (6 1/2 x 3 5/8 inches)
Resolution (H x V)	1920 x 1080 pixels (Full HD)		960 x 540 pixels (Quarter HD)
Aspect	16:9		
Panel drive	RGB 10-bit		
Viewing angle (Panel specification)	89°/89°/89° (typical) (up/down/left/right contrast > 10:1)		
<b>Input</b>			
Composite input	BNC (x1), 1.0 Vp-p ±3dB sync negative		
SDI input	BNC (x2)		
HDMI input	HDMI (x1) (HDCP correspondence)		
Audio input	Stereo mini jack (x1), -5 dBu 47 kΩ or higher		
Parallel remote	RJ-45 modular connector 8-pin (x1) (Pin-assignable)		
Serial remote (LAN)	RJ-45 modular connector (x1) (Ethernet, 10BASE-T/100BASE-TX)		
DC input	–	XLR-type 4-pin (male) (x1) DC 12 V to 16 V (output impedance 0.05 Ω or less)	XLR-type 4-pin (male) (x1) DC 12 V (output impedance 0.05 Ω or less)
<b>Output</b>			
Composite output	BNC (x1), Loop-through, with 75 Ω automatic termination		
SDI output	BNC (x2)		BNC (x1)
	Output signal amplitude: 800 mVp-p ±10% Output impedance: 75 Ω unbalanced		
Audio monitor output	Stereo mini jack (x1)		
Speaker (built-in) output	1.0 W (mono)		0.5 W (mono)
Headphone output	Stereo mini jack (x1)		
<b>General</b>			
Power requirements	AC 100 V to 240 V, 1.3 A to 0.6 A, 50/60 Hz	AC 100 V to 240 V, 0.9 A to 0.5 A, 50/60 Hz DC 12 V to 16 V, 6.4 A to 4.8 A	AC 100 V to 240 V, 0.5 A to 0.3 A, 50/60 Hz DC 12 V, 1.9 A
Power consumption	Approx. 115 W (max.) Approx. 80 W (average power consumption in the default status)	Approx. 75 W (AC power supply) (max.) Approx. 60 W (AC power supply) (average power consumption in the default status)	Approx. 30 W (max.) –
Operating temperature	0°C to 35°C (32°F to 95°F) Recommended: 20°C to 30°C (68°F to 86°F)		0°C to 40°C (32°F to 104°F) Recommended: 20°C to 30°C (68°F to 86°F)
Operating humidity	30% to 85% (no condensation)		
Storage / Transport temperature	-20°C to +60°C (-4°F to +140°F)		
Storage / Transport humidity	0% to 90%		
Operating / Storage / Transport pressure	700 hPa to 1060 hPa		
Dimensions (W x H x D)	581.0 x 386.6 x 65.5 mm* (22 7/8 x 15 1/4 x 2 5/8 inches) (without monitor feet)	435.0 x 274.0 x 65.5 mm* (17 1/4 x 10 7/8 x 2 5/8 inches) (without monitor feet)	222.4 x 166 x 70 mm (8 7/8 x 6 5/8 x 2 7/8 inches)
	581.0 x 409.1 x 165.0 mm (22 7/8 x 16 1/8 x 6 1/2 inches) (with monitor feet)	435.0 x 296.5 x 165.0 mm (17 1/4 x 11 3/4 x 6 1/2 inches) (with monitor feet)	222.4 x 183.5 x 161.8 mm (8 7/8 x 7 1/4 x 6 3/8 inches) (when AC adaptor is installed)
Mass	Approx. 6.1 kg (13 lb 7.2 oz)	Approx. 4.2 kg (9 lb 4.2 oz)	Approx. 2.0 kg (4 lb 6 oz) Approx. 2.6 kg (5 lb 12 oz) (when AC adaptor is installed)
Supplied accessories	AC power cord (1), AC plug holder (1), Before Using This Unit (1), CD-ROM (1)	AC power cord (1), AC plug holder (1), Handle (1) (including 4 screws), Before Using This Unit (1), CD-ROM (1)	AC power cord (1), AC plug holder (1), AC adaptor (1), Handle (1), Arm mount bracket (1), Screws (4), Operating instructions (1), CD-ROM (1), Using the CD-ROM Manual (1)
Optional accessories	SU-561 Monitor Stand, BKM-PP25 Protection kit	SU-561 Monitor Stand, MB-P17 Mounting bracket, BKM-PP17 Protection kit	MB-531 Mounting bracket, MB-532 Mounting panel, VF-510 Monitor ENG kit

\* Without projection parts.

	LMD-A240	LMD-A220	LMD-A170	LMD-941W
<b>Picture Performance</b>				
Panel	a-Si TFT Active Matrix LCD			
Picture size (diagonal)	611.3 mm (24 1/8 inches)	546.1 mm (21 1/2 inches)	419.6 mm (16 5/8 inches)	228.0 mm (9 inches)
Effective picture size (H x V)	518.4 x 324.0 mm (20 1/2 x 12 7/8 inches)	476.1 x 267.8 mm (18 3/4 x 10 5/8 inches)	365.8 x 205.7 mm (14 1/2 x 8 1/8 inches)	198.7 x 111.8 mm (7 7/8 x 4 1/2 inches)
Resolution (H x V)	1920 x 1200 pixels (WUXGA)	1920 x 1080 pixels (Full HD)		
Aspect	16:10	16:9		
Colors	Approx. 1,073 million colors	Approx. 16.7 million colors		
Viewing angle (Panel specification)	89°/89°/89°/89° (typical) (up/down/left/right contrast > 10:1)			
<b>Input</b>				
Composite input	BNC (x1), 1.0 Vp-p ±3 dB sync negative			
SDI input	BNC (x2)			
HDMI input	HDMI (x1) (HDCP correspondence)			
Audio input	Stereo mini jack (x1), -5 dBu 47 kilohms or higher			
Parallel remote	RJ-45 Modular connector 8-pin (x1)			
Serial remote	RJ-45 Modular connector (x1) (Ethernet, 10BASE-T/100BASE-TX)			
DC input	XLR-type 4-pin (male) (x1) DC 12 V to 17 V (output impedance 0.05 Ω or less)		XLR-type 4-pin (male) (x1) DC 12 V (output impedance 0.05 ohms or less)	
<b>Output</b>				
Composite output	BNC (x1), loop-through, with 75 ohms automatic terminal function			
SDI output	BNC (x2) Output signal amplitude: 800 mVp-p ±10% Output impedance: 75 Ω unbalanced			BNC (x1)
Audio monitor output	Stereo mini jack (x1)			
Speaker (built-in) output	1.0 W (monaural)		0.5 W (monaural)	
Headphones output	Stereo mini jack (x1)			
<b>General</b>				
Power requirements	AC 100 V to 240 V, 0.5 A to 0.2 A, 50/60 Hz DC 12 V to 17 V, 3.6 A to 2.6 A	AC 100 V to 240 V, 0.5 A to 0.2 A, 50/60 Hz DC 12 V to 17 V, 3.4 A to 2.4 A	AC 100 V to 240 V, 0.5 A to 0.2 A, 50/60 Hz DC 12 V to 17 V, 3.6 A to 2.5 A	AC 100 V to 240 V, 0.7 A to 0.4 A, 50/60 Hz DC 12 V, 2.5 A
Power consumption	Approx. 51 W (max.) Approx. 45 W (average power consumption in the default status)	Approx. 47 W (max.) Approx. 43 W (average power consumption in the default status)	Approx. 49 W (max.) Approx. 42 W (average power consumption in the default status)	Approx. 36 W (max.)
Mass	7.6 kg (16 lb 12 oz) (with monitor feet)	5.4 kg (11 lb 14 oz) (with monitor feet)	4.9 kg (10 lb 13 oz) (with monitor feet)	2.0 kg (4 lb 6.5 oz) 2.6 kg (5 lb 12 oz) (when AC adaptor is installed)
Supplied accessories	AC power cord (1), AC plug holder (1), Before Using This Unit (1), CD-ROM (1)	AC power cord (1), AC plug holder (1), Handle (1) (including 4 screws), Before Using This Unit (1), CD-ROM (1)		AC power cord (1), AC adaptor (1), AC plug holder (1), Handle (1), Arm mount bracket (1) (including 4 screws), Operating Instructions (1), CD-ROM (1), Using the CD-ROM Manual (1)

## Options



**BKM-PP25**  
Protection kit  
(for PVM-A250)



**BKM-PP17**  
Protection kit  
(for PVM-A170)



**BKM-PL17**  
Protection kit  
(for LMD-A170)



**MB-P17**  
Mounting bracket  
(for PVM-A170)



**MB-L22**  
Mounting bracket  
(for PVM-A250 and LMD-A220)



**MB-L17**  
Mounting bracket  
(for LMD-A170)



**SU-561**  
Monitor stand



**MB-531**  
Mounting Bracket  
(for PVM-741 and LMD-941W)



**MB-532**  
Mounting Panel  
(for PVM-741 and LMD-941W)



**VF-510**  
ENG Kit (Viewing Hood,  
Carrying Handle and  
Connector Protector)  
(for PVM-741 and LMD-941W)

# Dimensions

Unit: mm (inches)

## PVM-A250

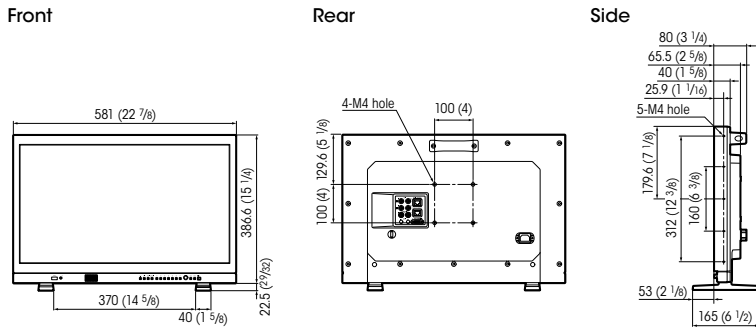

## LMD-A240

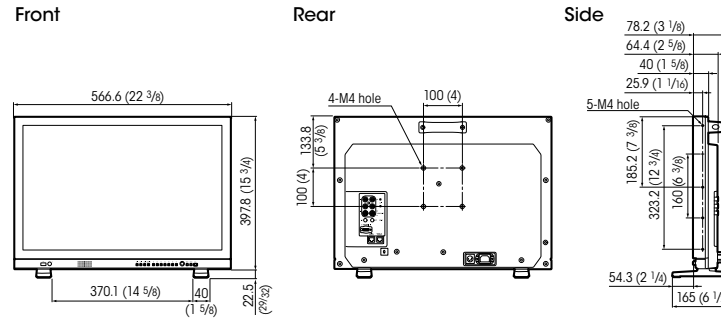

## LMD-941W

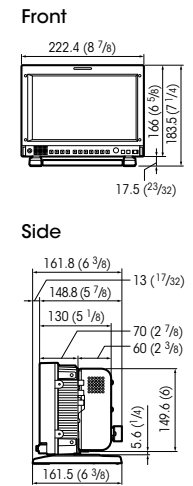

## PVM-A170

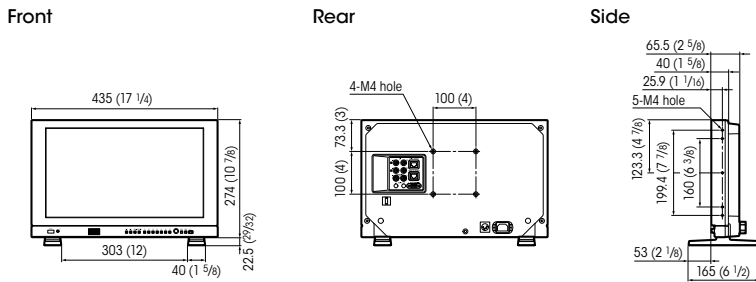

## LMD-A220

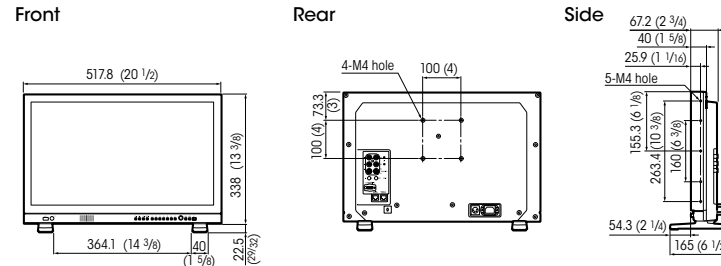

## PVM-741

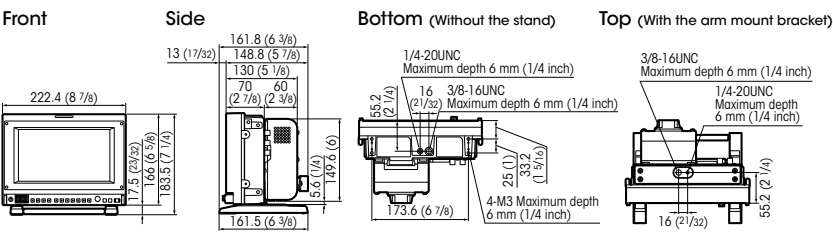

## LMD-A170

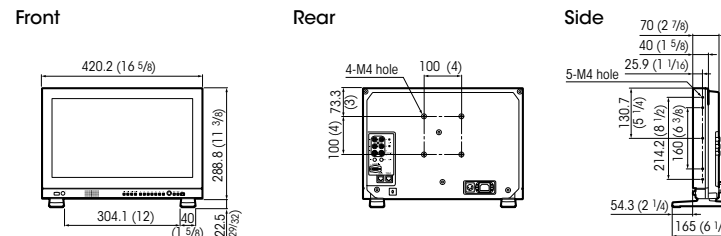

Distributed by

©2014 Sony Corporation. All rights reserved.  
 Reproduction in whole or in part without written permission is prohibited.  
 Features and specifications are subject to change without notice.  
 Screen images are simulated.  
 The values for mass and dimension are approximate.  
 "SONY" and "TRIMASTER EL" are trademarks of Sony Corporation.  
 HDMI is a trademark of HDMI Licensing, LLC.  
 All other trademarks are the properties of their respective owners.

MK11128V1EYIT4MAR

The PVM-A250 and PVM-A170 are produced at Sony EMCS Corporation Kosai Site, which has received ISO14001 Environmental Management System certification.

